



VEGA HOLSTER

CATALOG XXI

ALWAYS AHEAD

PAG. 4/73 > **DUTY** HOLSTERS AND ACCESSORIES

DUTY **D**

PAG. 74/115 > **TACTICAL** HOLSTERS AND ACCESSORIES

TACTICAL **T**

PAG. 116/163 > **CONCEALMENT** HOLSTERS

CONCEALMENT **C**

PAG. 164/171 > **SPORT > EYEWEAR**

SPORT **S**

PAG. 172/183 > **GLOVES**

GLOVES **G**

PAG. 184/187 > **ACCESSORIES**

PAG. 188/189 > **VEGA WORLD**

+

With an absolute dedication for consistent quality and service, Vega Holster has made a strong reputation for itself to Police & Military units all over the World since 1993, using only top quality materials and highly advanced manufacturing techniques with the strictest quality control. We've engineered the most innovate solutions for reliability and versatility in our tactical gear and holsters. Our goal is always been equipping the nations bravest with the best lifesaving gear they can depend on. From holsters to magazine carriers to police duty belt rigs, we'll always have the right gear for our consumers, for any mission, so they can protect what matters to their and be always ahead.

VEGA HOLSTER > **ALWAYS AHEAD**

> PAG. 190 > SALES & SIZE DETAILS
> PAG. 191 > MATERIALS & CARRY OPTIONS
> PAG. 192/193 > CATALOG GUIDE

GUIDE

DUTY

HOLSTERS AND ACCESSORIES FOR LAW ENFORCEMENT

- 6 / 10** POLYMER CAMA HOLSTERS
- 11** POLYMER ACE HOLSTERS
- 12** POLYMER SHOCKWAVE HOLSTERS
- 13** POLYMER INJECTION MOLDED HOLSTERS
- 14 / 16** POLYMER THERMO MOLDED HOLSTERS
- 17 / 19** WEAPONS + LIGHT POLYMER HOLSTERS
- 20 / 21** NO LETHAL WEAPONS POLYMER HOLSTERS
- 22 / 25** BELT LOOPS
- 26 / 27** CONNECT/DISCONNECT CARRY SYSTEMS
- 28 / 31** THIGH PLATFORMS
- 32 / 39** POLYMER ACCESSORIES
- 40 / 41** POLYMER DUTY SETS
- 42 / 44** NYLON HOLSTERS
- 45** NYLON NO LETHAL WEAPONS HOLSTERS
- 46 / 47** NYLON FLAP HOLSTERS
- 48 / 53** NYLON ACCESSORIES
- 54 / 55** NYLON DUTY SETS
- 56 / 57** LEATHER HOLSTERS
- 58** LEATHER FLAP HOLSTERS
- 59 / 62** LEATHER ACCESSORIES
- 63** BATON TONFA HOLDERS
- 64** BIBBS & ACCESSORIES FOR TRAFFIC CONTROL
- 65** ID BADGES & WALLETS
- 66 / 67** LEATHER DUTY SETS
- 68 / 73** DUTY BELTS



DUTY > POLYMER CAMA HOLSTERS



series
DCX8 "CAMA X"

PROFESSIONAL INJECTION MOLDED POLYMER HOLSTER
Double safety system of which one locks the upper part of the weapon and a lower safety system which acts on the trigger guard and automatically activates when the weapon is inserted in the holster.
Both systems can be released either individually or simultaneously using a lever on the inside of the holster, operated with the thumb in a "BACK & GO" movement.
Retention screw for adjusting the friction of the holster on the weapon.
Belt loop with double slots and adjustment of belt passage from 5 cm to 6 cm, grip position on the belt line.
It can be mounted on all Vega Holster loops and kits.

AVAILABLE FOR
-Glock 17/18/19/22/23/31/32/45/47 -Sig Sauer P320 Full Size/Compact/M17/M18



DUTY > POLYMER CAMA HOLSTERS



series
DCX08 "CAMA X OPEN"

PROFESSIONAL INJECTION MOLDED POLYMER HOLSTER
Lower safety system that acts on the trigger guard and automatically activates when the weapon is inserted in the holster.
The system is released by means of a thumb-operated lever on the inside of the holster, in a "BACK & GO" movement.
Retention screw for adjusting the friction of the holster on the weapon.
Belt loop with double slots and adjustment of belt passage from 5 cm to 6 cm, grip position on the belt line.
It can be mounted on all Vega Holster loops and kits.

AVAILABLE FOR
-Glock 17/18/19/22/23/31/32/45/47 -Sig Sauer P320 Full Size/Compact/M17/M18



DUTY **D**

TACTICAL **T**

CONCEALMENT **C**

SPORT **S**

GLOVES **G**

+

GUIDE



series **DCH8** "CAMA"

PROFESSIONAL INJECTION MOLDED POLYMER HOLSTER

Retention screws and clip with double friction.
Thumb release of the upper safety lock. Index finger release of the lower safety lock.
Possibility of closing the bottom opening.
Possibility of fully covered index finger safety lever.
Belt loop with double slots and grip height above belt height.
It can be mounted on all Vega Holster loops and kits.

AVAILABLE FOR
-Glock 17/22/19/23/18/ 31/32/45/47 -Beretta 92/98/90 A1, PX4 Stand., APX -H&K P30/P30L, H&K VP9/SFP9

SAFETY GRADE 3 not for all models



Front shield OUT INCLUDED



Front shield IN INCLUDED



Removable closing cup (no all models)

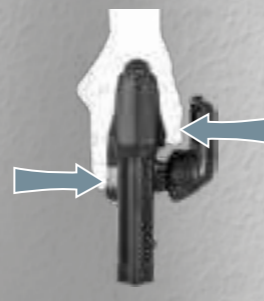

Release button



Partial cover INCLUDED



Total cover INCLUDED



Front shield OUT INCLUDED



Front shield IN INCLUDED



Removable closing cup (no all models)



Release button

DCH08 with all included options mounted.

series **DCH08** "CAMA OPEN"

PROFESSIONAL INJECTION MOLDED POLYMER HOLSTER

Upper opening with front protection.
Retention screws and clip with double friction points.
Index finger release of the lower safety lock.
Possibility of closing the bottom opening.
Possibility of fully covered index finger safety lever.
Belt loop with double slots and grip height above belt height.
It can be mounted on all Vega Holster loops and Kits.

AVAILABLE FOR
-Glock 17/22/19/23/18/31/32/45/47 -Beretta 92/98/90A, APX, -H&K P30/P30L, VP9/SFP9

SAFETY GRADE 2 not for all models



series **DCA8** "ONE FOR TWO"

PROFESSIONAL INJECTION MOLDED POLYMER HOLSTER
Retention screws and multi friction polymer spring.
The thumb releases the double safety mechanism: the first one works on the pistol upper part; the second one works directly on the trigger guard.
Possibility to close the bottom opening.
Belt loop with double slots, adjustable height and angle.
It can be mounted on all Vega Holster loops and kits.

AVAILABLE FOR
Beretta 92/98 Fs, - Beretta 92 A1, -Glock 17/19/22/23/31/32/45/47



DOUBLE SAFETY THUMB RELEASE LEVER

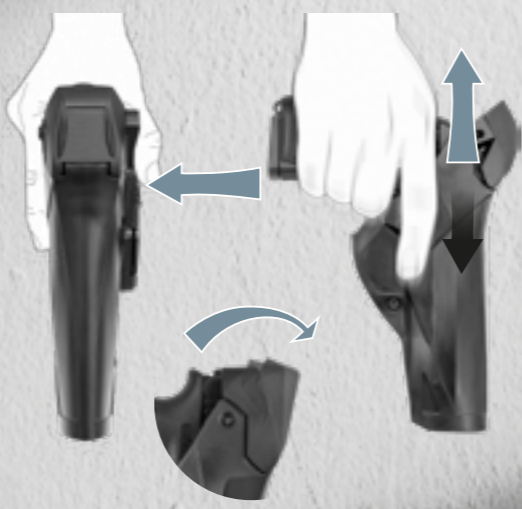

series **DAA8** "ACE"

PROFESSIONAL INJECTION MOLDED POLYMER HOLSTER
"Push & Front" upper safety system uses a swivel strap acting on the upper part of the weapon, releasable by means of a downward and then forward movement of the thumb.
"Front Stop" safety system, acting on the ejection hole, releasable by means of a lever located on the inside of the holster, thumb-operated in a natural rear movement.
Retention screw for adjusting the friction of the holster on the weapon.
Belt loop with double slots and adjustment of belt passage from 5 cm to 6 cm, grip position on the belt line.
It can be mounted on all Vega Holster loops and kits.

AVAILABLE FOR
-Glock 17/18/19/22/23/31/32/45/47 -H&K USP Compact -Sig Sauer P320 Full Size/Compact/M17/M18



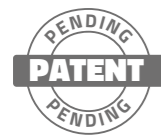

series **SHWD8** "SHOCKWAVE"

HOLSTER SUITABLE FOR UNIFORM OR TACTICAL PROFESSIONALS USES
 Made in special injection molded polymer. The double safety mechanism gives to the operator the possibility to put the firearm in maximum safety, useful during dangerous situations like riots, revolts, sport events and, with the opportunity to remove the superior safety system A and to have always the security system of the trigger guard locked. The firearm is at safety but at the same time it is ready to be use thanks to easy unlocked. The conformation of the two safety mechanisms (that use the thumb and medium Finger) allows the simultaneous unlocking of them (good training is recommended before used).
 A) Patented superior semiautomatic safety mechanism with an internal rotating cover (this unique rotation avoids the risk of locking that can be verified with frontal or external rotation).
 B) Patented automatic safety mechanism on the trigger guard.
 When the Pistol is inserted in the holster the safety automatically is activated. To release the Firearm, push on the lever under the Pistol grip, with the Middle finger in natural position.
 Retention screw on the barrel.
 It can be mounted on all Vega Holster loops and Kit.

AVAILABLE FOR
Beretta 92/96/98/ 31/32/45/47 -**Glock** 17/19/22/23/31/32/38/3 -**H&K** USP Standard, USP Compact -**Sig Sauer** 2022

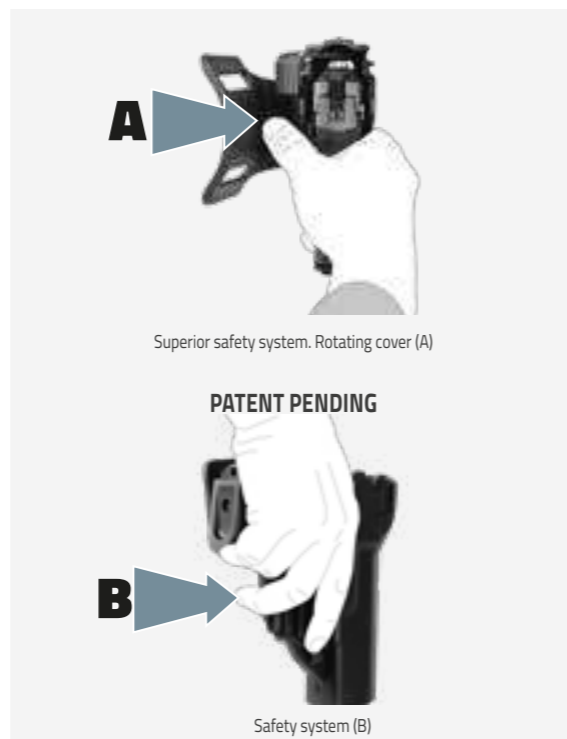

series **SHWP8** "POLICE-INJECTION"

HOLSTER FOR TACTICAL OR PROFESSIONAL USE IN UNIFORM
 In special polymer, with injection-molded increased thickness. The safety system with upper swivel strap means the operator can keep his weapon safe in any situation but also ready to use thanks to the fast opening swivel system requiring mere pressure of the thumb and frontward rotation. The holster is fitted with a "SAFETY GUARD" which prevents the safety catch from getting tangled in clothing or equipment and protects it from potential aggressors. The holster is fitted with a retention screw to adjust the retention of the weapon in the holster even with the safety catch not on. Compatible with all Vega Holster Belt loops and platforms kits.

AVAILABLE FOR
 -Walther PPQ, P99Q



series **SHWG8** "GUARDIAN-INJECTION"

HOLSTER FOR TACTICAL OR PROFESSIONAL USE
 Holster in special polymer injection molding, suitable for uniformed professionals and tactical operators. The security system is the result of the combination of two mechanisms from "Vega Push Down" and "Vega Automatic Push and Go". These two systems work simultaneously, providing the operator maximum safety, but, at the same time, in case of necessity, a quick draw in one single motion.. An adjustable retention screw assures perfect weapon stability in the holster.

AVAILABLE FOR
 -Taurus PT24/7 old gen. and -Taurus PT809





series **VKG8** "VEGATEK GUARDIAN"

PROFESSIONAL DUTY AND LAW ENFORCEMENT HOLSTER
The Safety Mechanism it is the union of two different mechanism "Vega Push Down" and "Vega Automatic Push and Go", these two systems work together and give the maximum safety to the operator but at the same time in case of necessity the draw it so fast with only one movement. Full protection of the firearm. High resistant polymer. Internal cover for better protection of the firearm and less noise emission. Compatible with all Vega Holster Belt loops and platforms kits.

AVAILABLE FOR
Beretta 92/96/98/PX4 -Glock 7/19/22/23/31/32/37/38/ 31/32/45/47
-H&K USP Standard, USP Compact, P30 -Sig Sauer 2022 -Walther P99 last edition

SAFETY GRADE 3 APG PD



series **VKE8** "VEGATEK EXTREME"

DUTY HOLSTER WITH EXCELLENT SAFETY SYSTEM
Excellent safety System VEGA PUSH DOWN which is automatically activated when the firearm is inserted in the holster and released with an easy and natural lever push action. Open on the top for a better fast draw. Full protection of the firearm. High resistant polymer. Internal cover for better protection of the firearm and less noise emission. Double holes belt loop included. Compatible with all Vega Holster Belt loops and platforms kits.

AVAILABLE FOR
Beretta 92/96/98/PX4 -Glock 17/19/22/23/31/32/37/38/45/47 -H&K Standard, USP Compact, P30 -Sig Sauer 2022

SAFETY GRADE 2 PD

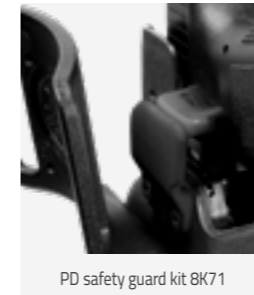

series **VKT8** "VEGATEK TOP"

PROFESSIONAL HOLSTER
Vegatek thermo - molding, internal soft lining for better protection of the firearms and less noise emission. Triple safety system: the first easy action safety system on the top; the second Vega Pull Side which is automatically activated when the firearm is inserted in the holster and released with an easy and natural hand's move, on it there is the possibility to insert a further level of locking safety to increase the safety grade. Retention screw on the barrel. Compatible with all Vega Holster Belt loops and platforms kit.

AVAILABLE FOR
Beretta 84/92/96/98/PX4/ APX -Glock 17/19/22/23/31/32/37/38/45/47 -H&K VP9/SFP9, P30, USP Standard, USP Compact -Sig Sauer 2022 -Tanfoglio Police, Pro -Walther P99 last edition

SAFETY GRADE 4

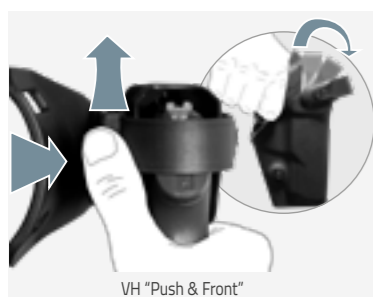

series **VKP8** "VEGATEK PRO"

DUTY HOLSTER
Holsters with excellent belt-loop system and a safety system which is automatically activated when the firearm is inserted in the holster and released with an easy and natural hand's move. It's possible to insert a further level of locking safety. Full protection of the firearm. High resistant polymer. Internal cover for better protection of the firearm and less noise emission. VEGA PULL SIDE automatic safety system. VEGATEK thermo-moulding. Compatible with all Vega Holster Belt loops and platforms kits.

AVAILABLE FOR
Beretta 92/96/98/PX4/APX -Glock 17/19/22/23/31/32/37/38/45/47 -H&K USP Standard, USP Compact -Sig Sauer 2022 -Walther P99 last edition

SAFETY GRADE 3

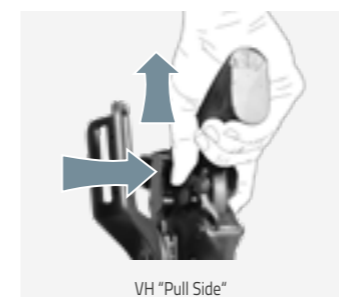



DUTY > POLYMER THERMO MOLDED HOLSTERS

series

VKD8 "VEGATEK DUTY"

VEGATEK THERMO-MOLDING PROFESSIONAL HOLSTER

Internal soft lining for better protection of the firearms and less noise emission. Easy action safety system on the top. Retention screw on the barrel. Compatible with all Vega Holster belt loops and platforms kit.

AVAILABLE FOR

-Beretta APX, 84/92/96/98/PX4, 90 two, 98 a1 -Colt 1911, e simili -Glock 17/19/20/21/22/23/31/32/37/38/45/47 -H&K VP9/SFP9, P30, USP Standard, USP Compact -Sig Sauer P320, 2022, P226Rail, P250 -Tanfoglio Police, Pro -Walther P99 last edition, PPQ, P99Q -FN Five Seven N -CZ SP01 -Caracal F and C -Revolver S&W 3" and 4" K & L Frame -S&W M&P M2.0 5"



series

VKDS8 "DUTY-SAFETY"

SPECIAL THERMO-MOLDED POLYMER HOLSTER

Suitable for duty and tactical operators. Inner lining to provide greater weapon safety and sound-free handling. Upper safety system with front adjustable rotating lace through three holes. Possibility of locking the rotating lace by means of a sliding mechanism to impede downward movement. It can be used with or without internal shield (both components are included). Retention screws on barrel. Compatible with all Vega Holster Belt loops and platforms kit.

AVAILABLE FOR

-Beretta APX, H&K VP9/SFP9, 81/84/92/98/PX4/90/90Two/98 A1 -Colt 1911 e cloni (Rail Included) -Glock 17/19/20/21/22/23/31/32/37/38/45/47 -H&K P30/USP stand. And Compact. -Sig Sauer P320/P226 (Rail included)/P250/2022 -Tanfoglio Police/Force/Pro -Walther P99/PPQ/P99Q -FN Five Seven N -CZ SP01 -Caracal F and C -Revolver S&W 3" and 4" K & L Frame -S&W M&P M2.0 5"



series

VKM8 "VEGATEK MIX"

VEGATEK THERMO-MOLDING PROFESSIONAL HOLSTER

Perfect Mix of durability and esthetics. In polymer with techno-leather outside. Internal soft lining for better protection and silence. Easy action safety system on the top. Retention screw on the barrel. Compatible with all Vega Holster belt loops and platforms kit.

AVAILABLE FOR

VKM800 -> Beretta 92/98 •VKM804 -Glock 17/22



DUTY > WEAPONS + LIGHT POLYMER HOLSTERS

series

VKQ8 "QUANTUM"

PROFESSIONAL THERMO MOLDED POLYMER HOLSTER SUITABLE FOR WEAPONS WITH TACTICAL LIGHTS AND/OR LASERS

ASPF" upper safety system adjusted by a swivel strap acting on the upper part of the weapon, releasable by means of a downward and then forward movement of the thumb. "Ace Front Stop" safety system, acting on the ejection hole, releasable by means of a lever located on the inside of the holster, thumb-operated in a natural rear movement. Retention screw for adjusting the friction of the holster on the weapon. Torch/Laser passage adjustment screw. Loop for belt with double slots and adjustment of belt passage from 5 cm to 6 cm, grip position on the belt line. It can be mounted on all Vega Holster loops and kits.

AVAILABLE FOR

-Glock 17/18/19/22/23/31/32/45/47 -Sig Sauer P320 Full Size/Compact/M17/M18 Mounted with Surfire X300/400, Streamlight TLR1/2 and similar sizes.



series

VKQR8 "QUANTUM PLUS"

PROFESSIONAL HOLSTER IN INJECTION MOLDED POLYMER SUITABLE FOR TACTICAL LIGHTS AND/OR LASERS AND FRONT RDO MOUNTING

ASPF" upper safety system adjusted by a swivel strap acting on the upper part of the weapon, releasable by means of a downward and then forward movement of the thumb. "Ace Front Stop" safety system, acting on the ejection hole, releasable by means of a lever located on the inside of the holster, thumb-operated in a natural rear movement. Retention screw for adjusting the friction of the holster on the weapon. Torch/laser passage adjustment screw. Loop for belt with double slots and adjustment of belt passage from 5 cm to 6 cm, grip position on the belt line. It can be mounted on all Vega Holster loops and kits.

AVAILABLE FOR

-Glock 17/18/19/22/23/31/32/45/47 -Sig Sauer P320 Full Size/Compact/M17/M18 Mounted with Surfire X300/400, Streamlight TLR1/2 and similar sizes.





series **VKWM8** "VIRIDIAN LIGHT"

THERMO MOLDED POLYMER HOLSTER WITH LINING INSIDE

An internal special mechanism allows the VIRIDIAN Light to switch on when the gun is released and to switch off when the gun is inserted. Safety retention level II. Adjustable Retention screws. The Thumb releases the rotating safety lace, a small Catch can stop the rotating lace action. Duty Belt loop with double slots and adjustable angle. It can be mounted on all Vega Holsters belt loops and kit.

AVAILABLE FOR
-Glock 17/22 with Viridian X5L/X5L-R



series **VKW8** "VEGATEK WARRIOR"

FOR DUTY AND TACTICAL OPERATORS

Special thermo-molded polymer holster, suitable for Duty and tactical operators. Inner lining to provide greater weapon safety and sound-free handling. Upper safety system with rotating lace. It can be used with or without internal shield (both components are included). Retention screws on barrel.

Compatible with all Vega Holster Belt loops and platforms kit.

AVAILABLE FOR
-Glock 17/19/22/23/31/32/37/38/45/47 with Stremlight LT1 and LT2 -FN Herstal FNS9 with Surfire X300



series **VKZ8** "ZOOM"

PROFESSIONAL THERMO MOLDED POLYMER HOLSTER FOR WEAPONS WITH FLASHLIGHT

Easy action safety system on the top. Retention screw on the lower part of the pistol. Two adjustable parts in rubber and cordura at the point of the trigger guard according to the model of flashlight or/and laser mounted on the pistol. Compatible with all Vega Holster Belt loops and kit.

AVAILABLE FOR
-Glock 19/22/17/23/18/31/32/45/47 and similar with Flashlight or Laser -Sig Sauer P220/22 -Springfield XDM all With Laser or Light 6



series. **VUH8** "UNIVERSAL"

VEGA UNIVERSAL PISTOL/LIGHT HOLSTER

Polymer injection molded holster with internal adjustment to accommodate different types of weapons equipped with different types of torches/lasers. The holster is mounted with a lock system which automatically activates when the weapon is placed in the holster. The weapon disengages by placing the thumb on the lever situated at the rear end. The holster has removable frontal protection for greater front protection. The lower side incorporates a retention screw for slightly adjusting friction from the holster onto the gun. The holster is mounted on a standard polymer injection molded loop kit for police and/or law enforcement use. It can be mounted on all Vega Holster loops and kits.

AVAILABLE FOR
All the most common Large Auto and Large Auto Compact mounted with the most common flashlights/lasers on the market (verify weapon and flashlights compatibility with the holster before purchasing)





series
DTC8 "TASER ONE FOR TWO"

INJECTION POLYMER HOLSTER
Retention screws and multi friction polymer spring. The index releases the double safety mechanism, the first one works on the pistol upper part and the second one works directly on the weapon stem. Openable belt loop, adjustable height and angle. It can be mounted on all Vega Holster loops and kit.
International Patent
Available: right.

AVAILABLE FOR
-Taser X26P



series
DTCS8 "SEVEN HOLSTER"

PROFESSIONAL HOLSTER IN INJECTION MOLDED POLYMER
ASPF™ upper safety system adjusted by a swivel strap acting on the upper part of the weapon, releasable by means of a downward and then forward movement of the thumb. Retention screw for improved friction of the holster on the weapon.
The loop, which can be opened and adjusted in inclination and height, holds the holster close to the body with the grip above the centre line of the belt. It is also suitable for mounting on MOLLE type belts and supports.
It can be mounted on all Vega Holster loops and kits.

AVAILABLE FOR
-Taser 7



series
VNL8 "N.L.W."

THERMO MOLDED POLYMER HOLSTER WITH LINING INSIDE
Adjustable retention screws. The Thumb releases the rotating safety lace, a small catch can stop rotating lace action. Duty belt loop with double slots and adjustable angle. It can be mounted on all Vega Holster loops and kits

AVAILABLE FOR
-Taser X26P/X2, -Piexon JPX2/JPX4/JPX6



"TASER X2"



"TASER X26"



"JPX4"



"JPX2"

THE CHOICE OF A CARRYING SYSTEM BASED ON ONES OPERATIONAL ROUTINE AND NEEDS IT'S THE FIRST STEP TO HAVE THE IDEAL HOLSTER.

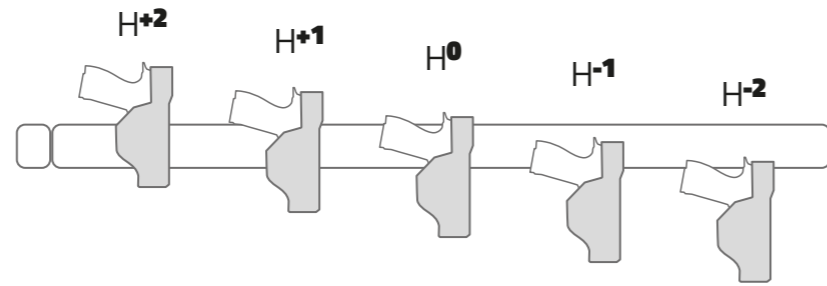

cod. **8K24**
INJECTION MOLDED SPECIAL POLYMER BELT LOOP
 Double holes for belt of 60 mm. Maximum height. Rotative system with more positions: vertical, inclined and semifixed 90° useful in the car. Multi-holes to adjust height and inclination with screws.



cod. **8K25**
INJECTION MOLDED SPECIAL POLYMER BELT LOOP
 Opening system on the two loops to wear or remove easily the Shockloop from the belt. Possibility to lock the opening system. Rotative system with more positions: vertical, inclined and semi-fixed 90°, useful in the car. Multi-holes to adjust height and inclination with screws.

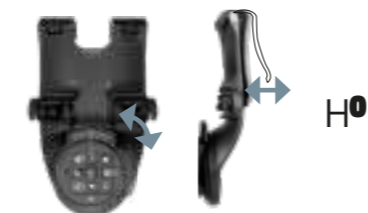

cod. **8K43**
COMPACT ROTATING BELT LOOP
 Adjustable belt slots. For belt up to 6 cm high. High position, holster grip on the middle belt line. The system allows a rotation of small angle for a better draw and a 90° rotation to be used in the car. The lever for adjusting the angles is on the sides.



cod. **8K44**
COMPACT ROTATING BELT LOOP
 Compact rotating belt loop middle lever. Polymer injection molded loop. The double eyelet with adjustable height allows use of belts up to 6 cm high. In vertical position, the weapon grip is above the center line of the belt. The kit allows rotation of the holster in a slightly tilted position and in a horizontal position. The lever for adjusting the angle is in a central position.



cod. **8K23**
INJECTION-MOLDED SPECIAL POLYMER BELT LOOP
 Double holes for belt of 60 mm. Maximum height. Multi-holes to adjust height and inclination with screws. Included in all Schockwave and Vegatek holsters, see the duty section.



cod. **8K40**
INJECTION MOLDED POLYMER PROFESSIONAL LOOP
 60 mm belt loop height with slots for 3 different positions (straight, front cant, cross-draw), high position.



cod. **8K41**
POLYMER STANDARD DUTY BELT LOOP
 That keeps the pistol distant from the body for tactical vest or body armor use. Adjustable belt slots for 6 cm height at maximum. Standard position, holster grip remains in the middle belt line.



cod. **8K42**
POLYMER LONG DUTY BELT LOOP
 That keeps the pistol distant from the body for tactical vest or body armor use. Adjustable belt slots for 6 cm height at maximum. Lower position, holster grip remains under the middle belt line.



cod. **8K90**
RUBBER COMFORT KIT FOR BELT LOOPS 8K41 AND 8K42
 The system mounted on the rear part of the belt loop system allows a better stability and comfort on the hip. Removable.

DUTY BELT LOOPS WITH FLAT SHAPE PROFILE



cod. **8KF01**
SHORT FLAT SHAPE DUTY BELT LOOP
 Flat shape" loop, in injected polymer, belt height adjustment bar, flexible tabs, tilt adjustment



cod. **8KF02**
STANDARD FLAT SHAPE DUTY BELT LOOP
 Flat shape" loop, in injected polymer, belt height adjustment bar, flexible tabs, tilt adjustment



cod. **8KF03**
ROTATING FLAT SHAPE DUTY BELT LOOP
 "Flat shape" rotating loop, in injected polymer, belt height adjustment bar, flexible tabs, tilt adjustment lateral lever, positions 0°, 10°, .90°.



cod. **8KF00**
MULTI-LENGTHS FLAT SHAPE DUTY BELT LOOP
 Multi-height, "flat shape" loop, in injected polymer, belt height adjustment.



cod. **8K22**
SQUARE DUTY BELT LOOP
 Injection molded polymer, ideal to use with 8K31 and 8K35 Kit (pag. 27).



DUTY > BELT LOOPS

cod. **8K21**

INJECTION-MOLDED SPECIAL POLYMER BELT LOOP
To wear the firearm near the body. Adjustable double holes for belt of 60 mm. Maximum height. Multi-holes to adjust height and inclination with screws.



H+1

cod. **8K26**

POLYMER BELT LOOP TO WEAR THE FIREARM NEAR THE BODY
Injection molded special polymer belt loop to wear the firearm near the body. Adjustable double holes for belt up to 60 mm high. Multi-holes to adjust height and inclination with screws.



H+1

cod. **8K27**

INJECTION MOLDED SPECIAL POLYMER PADDLE LOOP TO WEAR THE FIREARM NEAR THE BODY
Adjustable system in height for belt of 50mm. maximum height. Multi-holes to adjust height and inclination with screws.



H+1

cod. **8K85**

UP&DOWN BELT PLATFORM
Allowing for extreme comfort thanks to its flexibility and shape. Adjustable belt loops through double barrels, slots for three different positions (straight, front cant, cross-draw). Two carrying options: high (under the shoulder), or low (below the waist). Compatible with rotating system accessories for simultaneous use on the same platform.



H+2/-2

cod. **8K82**

MULTIPURPOSE ADJUSTABLE LOOP
Which can be opened and adjusted in height and cant through a series of slots. Belt adjustable height, lock with Safety system.



H+1

DUTY > BELT LOOPS

cod. **8K29**

POLYMER MODULAR PLATFORM
To attach the holster and accessories on tactical vest, rucksacks, thigh platform with molle system.

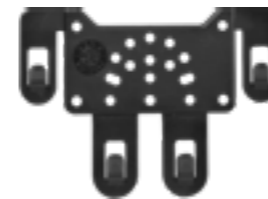

cod. **8K89**

KIT FOR MOLLE TYPE SUPPORTS
4 positions for polymer accessories with toothed wheel.



cod. **8K83**

ROTATING COMPACT MOLLE KIT
Allow the angle adjustment by screw.



cod. **8K87**

OPENABLE MULTI USE LOOP
Compatible with both duty belts and Molle system.



H+1

cod. **8K99**

TRIANGULAR WEDGE THICKNESS
To distance and incline the holster compared to the standard support.



cod. **8K98**

TRIANGULAR THICKNESS 5MM
To distance the holster compared to the standard support.



cod **8K33** "WHEEL ATTACH. SYSTEM"

MODULAR RAPID CONNECTION AND ROTATING SYSTEM

Male part can be mounted on the holster (compatible with all Vega polymer holsters). Female part can be mounted on every Vega Holster belt loops, thigh kits or Molle platforms. The two parts can be mounted on several holsters and different platforms so to change the position of the pistol quickly, also during an operative mission. The system allows a 360° rotation without any lever action.

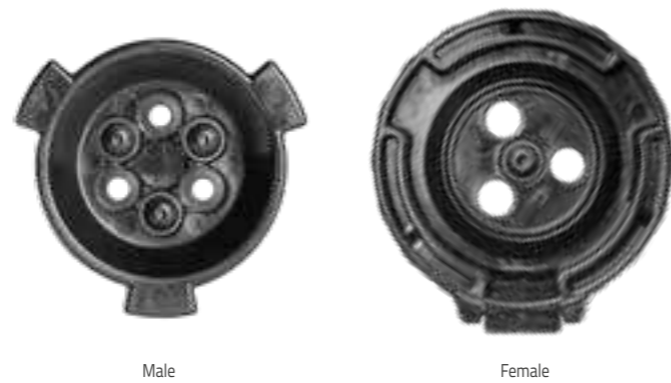

Male

Female

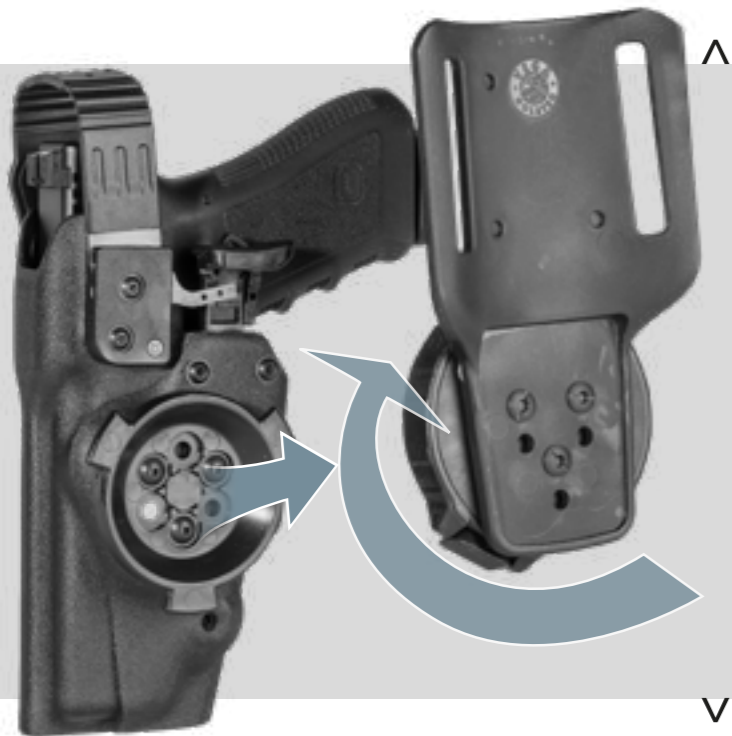

On MOLLE support



On thigh platform

cod **8K34** "W.A.S.F - WHEEL ATTACH. SYSTEM FLAT"

MODULAR QUICK COUPLING AND TILT ADJUSTMENT SYSTEM

The system is composed of a male part to be screwed/fixated to any Vega Holster polymer holster and a female counterpart to be fixed on any thigh support, MOLLE kit or Vega Holster loop system. Multiple parts (both female and male) can be attached to multiple holsters or supports, so that the positions of the weapon can be changed quickly even during a mission. The two, joined parts lock together by simply pressing and moving forward. Multiple holes allow different inclinations.



Male (Low profile)

Female (Low profile)

cod **8K31** "R.D.Q.A."

MODULAR MULTI-FUNCTION SYSTEM

The RDQA system allows you to connect or disconnect your holster from a belt loop, a thigh or a Molle platform. The system consists in two parts, the male one (M) mounted on the holster and the female one (F) mounted on a belt loop, a thigh or a Molle platform. Inserting (M) inside (F), they lock together. To disconnect you only have to push towards inside on the bottom parts (E and D), using thumb and index, and let move the holster upwards. On the surface of the female part there are many holes to allow you to change the angle and the high. With lever (G) you can change the angle of the holster choosing among straight, inclined or horizontal (car using) position.

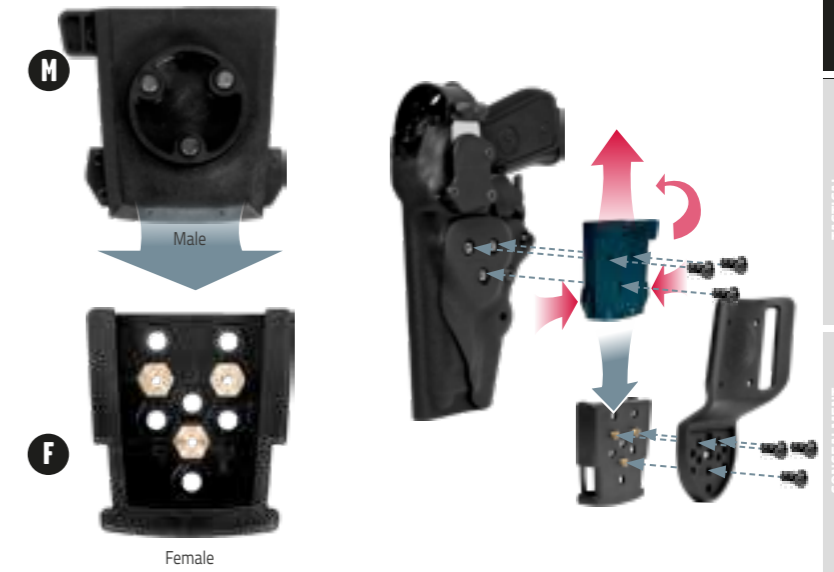

M

Male

F

Female

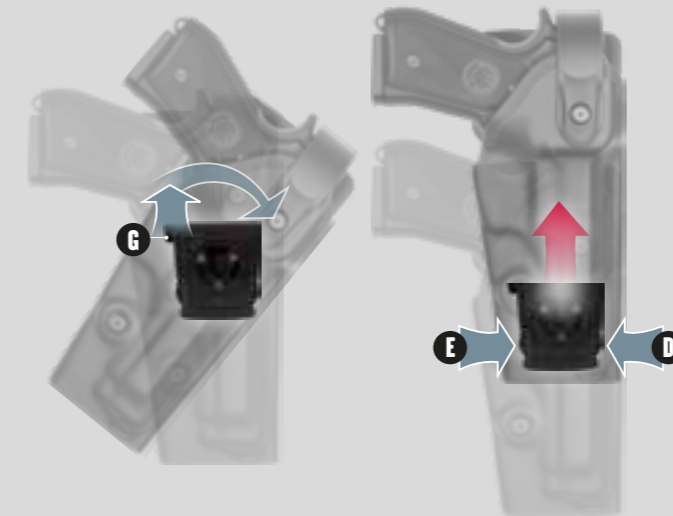

G

E

D



1 8K29 + 8K31 + VKD8

2 8K22 + 8K31 + VKD8

3 8K18 + 8K31 + VKD8

cod **8K35** "T.B.C. - THE BUCKLE CONNECT"

DISCONNECT/CONNECT QUICK SYSTEM

The system is composed of a male part to be screwed/fixated to any Vega Holster polymer holster and a female counterpart to be fixed on any thigh support, MOLLE kit or Vega Holster loop system. Multiple parts (both female and male) can be attached to multiple holsters or supports, so that the positions of the weapon can be changed quickly even during an operational mission. The two, joined parts lock with a simple downward pressure, to separate them press on the two lower side tabs and pull the male part upwards. Multiple holes allow different heights.

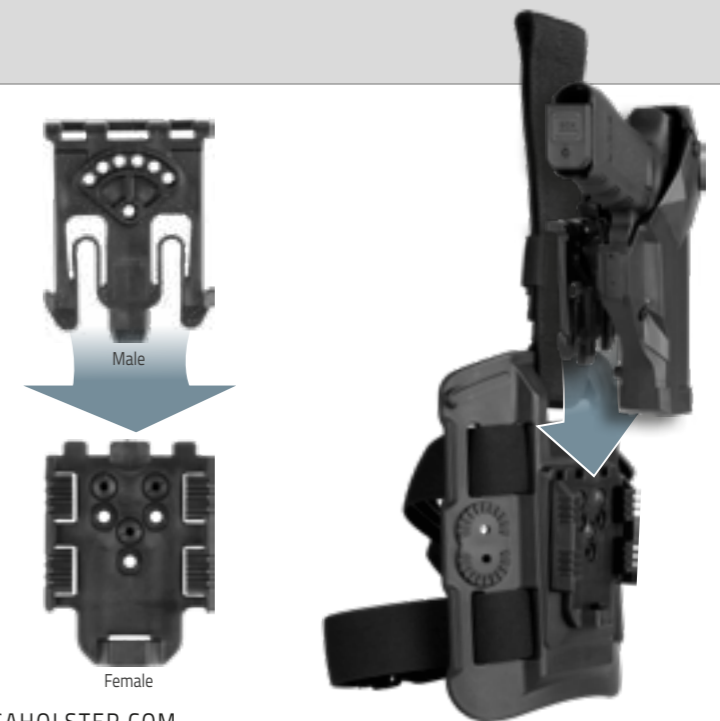

Male

Female



Double belt attach

Single belt attach

cod. **8K18**

POLYMER MULTI FASTENING THIGH PLATFORM. Dual no-slip leg straps for thigh wearing kit. Dual possibility of extension belt-thigh: dual thigh extension with swivel buckles and adjustable length Item. Central holes (Q) to mount the holster (see holsters compatibility) with possibility of a dual inclination. Dual attachment systems for accessories on the right and left sides; two holes (Z) to mount kit 8K36 or other accessories with screws (see under accessories). Two loops (J) to mount any Molle system (height compatible) or any modular system using universal clips 8MH00. Double rotative attach. Two points (Y) to insert mount magazine cod. 8MH00 or other compatible accessories.



cod. **8K16**

POLYMER MULTI FASTENING THIGH PLATFORM Dual no-slip leg straps for thigh wearing kit. Dual possibility of extension belt-thigh: single thigh extension adjustable with velcro. Central holes (Q) to mount the holster (see holsters compatibility) with possibility of a dual inclination. Dual attachment systems for accessories on the right and left sides: Two holes (Z) to mount kit 8K36 or other accessories with screws (see under accessories). Two loops (J) to mount any Molle system (height compatible) or any modular system using universal clip 8K75. Double rotative attach. Two points (Y) to insert mount magazine cod. 8MH00 or other compatible accessories.



Double belt attach

Single belt attach

cod. **8K12**

MULTI-PURPOSE INJECTION MOLDED POLYMER THIGH SUPPORT Double straps with non-slip bands for anchorage to the thigh. Double, adjustable thigh extension with swivel buckles and velcro fastening belt attachment. Central hole for attachment of VH holsters at various heights and inclinations. (K) Double toothed wheels for inserting compatible accessories. (H)



cod. **8K13**

MULTI-PURPOSE INJECTION MOLDED POLYMER THIGH SUPPORT Double straps with non-slip bands for anchorage to the thigh. Single Velcro adjustable thigh extension. Central hole for attachment of VH holsters at various heights and inclinations. (K) Double toothed wheels for inserting compatible accessories. (H)



COMPATIBLE ROTATING SYSTEM ACCESSORIES

cod. **8V31** with lock. cod. **8V33** without lock. Non Stop Retractable key and multi tools holder.

cod. **8MH01** Open double row magazine case with double retention screws

cod. **8MH00** Magazine holder, adjustable flap, inside spring.

cod. **8VP62** 21" baton case with adjustable screw.

cod. **8VP63** Light holder with adjustable screw

cod. **8K36** Picantiny rail.

ALL THIGH PLATFORMS ARE COMPATIBLE WITH ALL VEGA HOLSTER POLYMER HOLSTERS.

cod.
8K17

COMPACT THIGH PLATFORM

Injection molded polymer, single thigh strap with no-slip rails. Adjustable belt strap with a special swivel buckle for adapting to your body movements. Dual toothed wheel (Y) on the sides for attaching rotating system accessories compatible (see pag. 28/29), in the middle multi holes (Q) for attaching holster or other accessories (see pag. 35).



Platforms mounted with 8VP62, 8VAMH00 and 8MH00

cod.
8K20

POLYMER INJECTION MOLDED THIGH KIT

Adjustable holster height in three positions. Compact shape with central swivel to follow movements. Upper loop for fastening onto belts with large holes or through Molle system with small holes. Thigh support with swivel points and possibility of introduce rotating system accessories (see pag.28/29). Elastic with anti-slide silicon stripes.

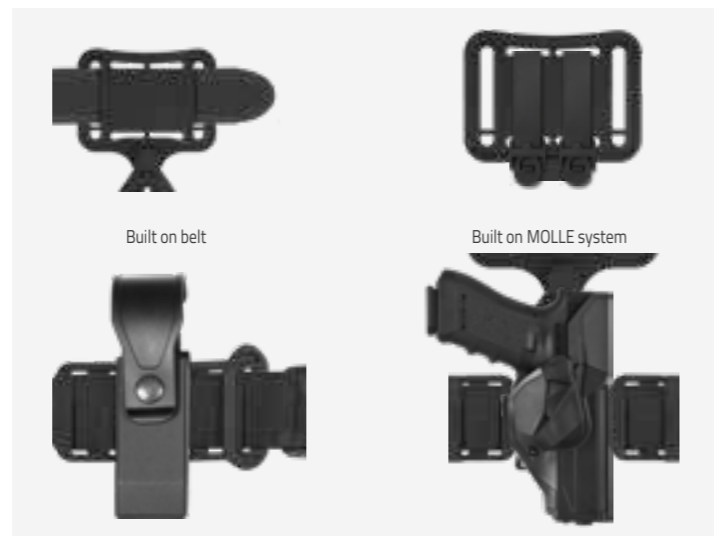

cod.
8K28

MULTI-LENGTHS FLAT SHAPE DUTY BELT LOOP WITH THIGH SUPPORT

Three heights positions. Thigh support with swivel points and possibility of introduce rotating system accessories (see pag.28/29). Elastic with anti-slide silicon stripes

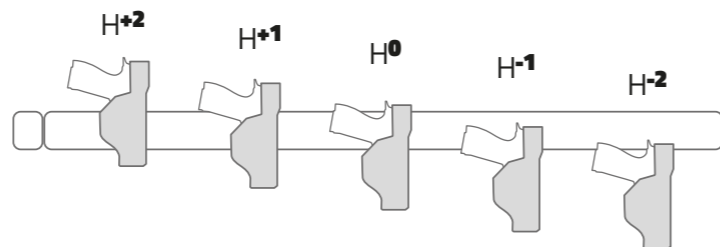



DUTY > POLYMER ACCESSORIES

cod.
8V10

Polymer baton, flashlight c/cell holder with plastic ring.



cod.
8V00

Molded belt keepers



cod.
8V02

Belt keeper with handcuffs key.



cod.
8V13

Polymer flashlight d/cell holder With plastic ring.



cod.
2PS07

Injection molded polymer key holder. Snaps closure



cod.
8V20

Polymer pistol safety lace



cod.
8VP30

21" Expandable baton holder. Retention screws.



cod.
8VP31

Flashlights Ø 23 mm holder. Retention screws.



cod.
8VP32

COS 40 ml holder. Retention screws.



DUTY > POLYMER ACCESSORIES

cod.
8V18

PLASTIC TONFA BATON HOLDER



cod.
8V19

TONFA HOLDER IN POLYMER AND NYLON With swivel loop.



cod.
8VP00

MAGAZINE HOLDER

Injection moulding polymer magazine case, guard belt loop, inside retention clip.



cod.
8VP25

HANDCUFFS HOLDER

Injection moulding plastic handcuffs case, guard belt loop.



cod.
8VP26

POLYMER THERMO MOLDED OPEN TOP HANDCUFF CASE

Passive retention system. The loop can be opened and adjusted through a multihole system. Adjustable belt height passage. For Clejuso N°9 handcuffs.



cod.
8VP27

HANDCUFF HOLDER IN THERMO MOLDED POLYMER

retention screw, openable loop with belt height and tilt adjustment. for Clejuso No. 9 handcuffs.



cod.
8VPT00 XP26

CARTRIDGE HOLDER FOR TASER X26 IN THERMO MOLDED POLYMER

Button-down flap, openable loop with belt height and tilt adjustment.



cod.
8VPT01 X2

CARTRIDGE HOLDER FOR TASER X2 IN THERMOFORMED POLYMER

Button-down flap, openable loop with belt height and tilt adjustment.



cod.
8VHH00

HANDCUFF CASE IN INJECTION MOLDED POLYMER

With fixed belt loop of H cm 5,5. Double cover flap for adjustment to all types of handcuff both with fixed and chain hinge. Double inner clip for improved retention of all types of compatible handcuffs. Detachable key ring positioned under the flap with spiral ring. Compatible with Rotating System accessories belt loops and kits by special kit 8K79, 8K81 e 8K80. Compatible with handcuffs VHOE60, OE61, OE64, OE50 and similar on the market.



cod.
8VRH00

RADIO CASE IN INJECTION MOLDED POLYMER

With fixed belt loop of H cm 5,5. Adjustable lace in tubular elastic and two detachable lateral adaptors to fit various types of radio. Double inner clip for improved retention of all types of compatible radio. Compatible with Rotating System accessories belt loops and kits by special kit 8K79, 8K81 and 8K80.

Internal measurements without adaptors: cm L 8,2 / P 4,2 / H 11,2



cod.
8VAMH00

AR MAGAZINE HOLDER 5, 56, 223, AR

injection molded polymer with fixed loop, H 5,5. Adjustable elastic strap. Dual internal clip for better retention. Compatible with rotating loops through kit 8K79.



cod.
8MMH00

UP&DOWN BELT PLATFORM

Allowing for extreme comfort thanks to its flexibility and shape. Adjustable belt loops through double barrels, slots for three different positions (straight, front cant, cross-draw). Two carrying options: high (under the shoulder), or low (below the waist). Compatible with rotating system accessories for simultaneous use on the same platform.

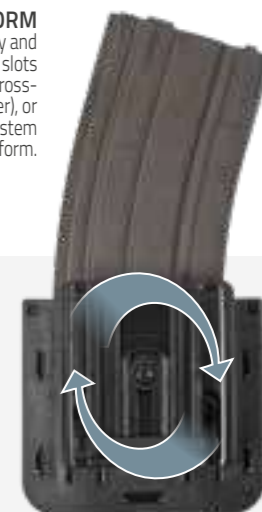

cod.
8V31/8V33

RETRACTABLE KEY/MULTI-TOOLS HOLDER, BELT LOOP AND MOLLE KIT INCLUDED

Polymer injection molded. Strong DYNEMA cord and special spring with 0,6 kg force contain. Rotative Safety system to block the final parts in the case. Double slot loop with adjustable inclination with screws.

- 8V31 with final part rotating system lock;
- 8V33 without final part rotating system lock;

Compatible with loops for rotative system accessories.





DUTY > POLYMER ACCESSORIES



cod.
8MH00

TWO-ROW MAGAZZINE CASE
Adjustable flap cover, inside retention spring. Rotating belt loop with adjustable angle and adjustable belt heights.



cod
8MHH03

For long magazines

CLOSED TWO-ROW MAGAZINE CASE
Injection molded polymer can be used with clips for inside or outside use, or with any rotating loop/kit system. Button down flap, adjustable in 2 height positions and detachable. 360° inclination adjustable screw.



cod
8MHH04

For short magazines type G.26



cod
8MHH01

For long magazines

OPEN TWO-ROW MAGAZINE CASE
Injection molded polymer can be used with clips for inside or outside use, or with any rotating loop/kit system. 360° inclination adjustable screw. The double retention screws allow adjustment of the friction on the magazine.



cod
8MHH02

For short magazines type G.26

cod.
8DMH01

DOUBLE TWO ROW UNIVERSAL MAGAZINE CASE
In injection molded polymer with belt loop permitting both horizontal and vertical positions. Belt loop height adjustment to the belt used. Flap adjustable in length and removable for an open use of the magazine case. Detachable outer snap cover. Inner clip for improved retention.

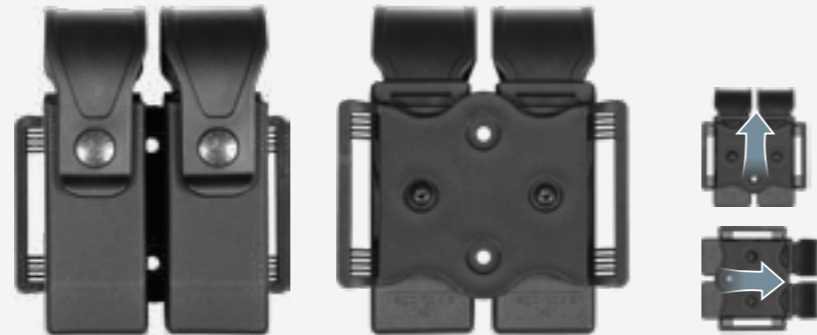

cod
8DMH04

DOUBLE CLOSED TWO-ROW MAGAZINE CASE
In injection molded polymer
Tilt-adjustable opening belt and molle compatible loop. It can be used with any rotating loop/kit system.
Button-down flap, detachable.
The double retention screws allow adjustment of the friction on the magazines.



cod
8DMH03

INJECTION POLYMER DOUBLE MAGAZINE HOLDER (DOUBLE AND SINGLE ROW)
Designed to hold the most part of pistol magazine cases.
Special adapter for single row magazine.
Double adjustment screws.
Openable and 360° rotative belt loop.
Compatible with Vega Holster rotative belt loops and kit.



DUTY > POLYMER ACCESSORIES

cod.
8VP62

ROTATING BATON CASE.
Polymer injection molding 21" baton case. Openable rotating belt loop. Clip hold. Rotation by screw.

8VP62 Bonowi Eka Extendable fast draw system compatible
8VP629 ASP Extendable fast draw system compatible



cod.
8VP63

ROTATING LIGHT AND BATON 16" HOLDER.
Polymer injection molded flashlight and baton holder. Openable rotating belt loop. Clip hold. Compatible with the most popular Flashlight diameter +/- 3,3 cm. Rotation by screw.



cod
8VP65

INJECTION MOLDED POLYMER 24"/26" BATON HOLDER
Rotating openable belt loop with with safety system and belt height adjustment.
Multi-clip retention system.
Compatible with loops for rotating system accessories.
Internal system for opening on extraction of Bonowi Eka type baton.



cod
8VP66

INJECTION MOLDED POLYMER 21" WITH FLAP CLOSURE
Buttondown flap, detachable.
Rotating openable belt loop with safety system and belt height adjustment.
Rotation uses "PULL & TURN" system.
Multi-clip retention system.
Internal system for opening on extraction of Bonowi Eka type baton.



DUTY **D**

TACTICAL **T**

CONCEALMENT **C**

SPORT **S**

GLOVES **G**

+

GUIDE



DUTY > POLYMER ACCESSORIES

P.T.R.S.

PULL & TURN ROTATING SYSTEM

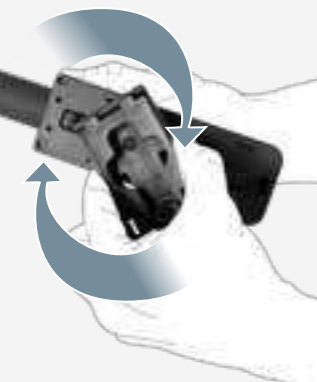

cod. **8VP60**

BATON CASE WITH ADJUSTABLE SCREW

Polymer injection molded 21" baton case. Double slot loop with adjustable inclination with screws. Clip hold. Inner system for Bonowi Camlock Baton opening during the draw.

8VP60
compatible with fast draw Bonowi system
8VP609
compatible with fast draw ASP system



cod. **8VP61**

LIGHT AND BATON 16" HOLDER

Polymer injection molded. Double slot loop. Clip hold. Compatible with the most popular flashlight diameter +/- cm 3,3.



cod. **8VP67**

BATON HOLDER 24/26" IN INJECTION MOLDED POLYMER

Rotating openable belt loop with safety system and belt height adjustment. Rotation uses Pull & Turn system. Multi-clip retention system. Internal system for opening on extraction of Bonowi Eka type baton.



cod. **8VP64**

INJECTION POLYMER TONFA BATON HOLDER

Designed to hold the most part of baton models. Safety rotating lace with safety snap. Openable and 360° rotative belt loop.



P.T.R.S. > BELT LOOPS

cod. **8K91** "LONG SIZE"

ADJUSTABLE ALL USES ROTATING LOOP
Double use belts and Molle. Openable with double lock system, bar for adjusting height of belt and Molle system passage.



cod. **8K88** "SHORT SIZE"

ADJUSTABLE ALL USES ROTATING LOOP
Openable with double lock system. Bar for adjusting height of belt passage from 4 cm to 6,5 cm.



DUTY > POLYMER ACCESSORIES

cod. **8K82**

MULTIPURPOSE ADJUSTABLE LOOP

Which can be opened and adjusted in height and cant through a series of slots. Belt adjustable height, lock with Safety system.



cod. **8K87**

OPENABLE MULTI USE LOOP

Compatible with both duty belts and Molle system.



cod. **8K81**

COMPACT ROTATING BELT LOOP

Double 5,5 cm Slots.

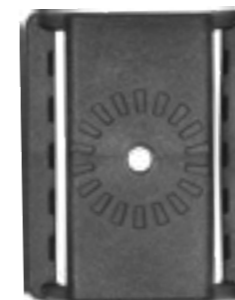

cod. **8K84**

ROTATING BELT LOOP

Adjustable belt sizes passage.



cod. **8K83**

ROTATING COMPACT MOLLE KIT

Allow the angle adjustment by screw.



cod. **8K50**

ROTATING SYSTEM CLIP

System for reducing belt passage.



cod. **8K89**

KIT FOR MOLLE TYPE SUPPORTS

4 positions for polymer accessories with toothed wheel.





SET A1

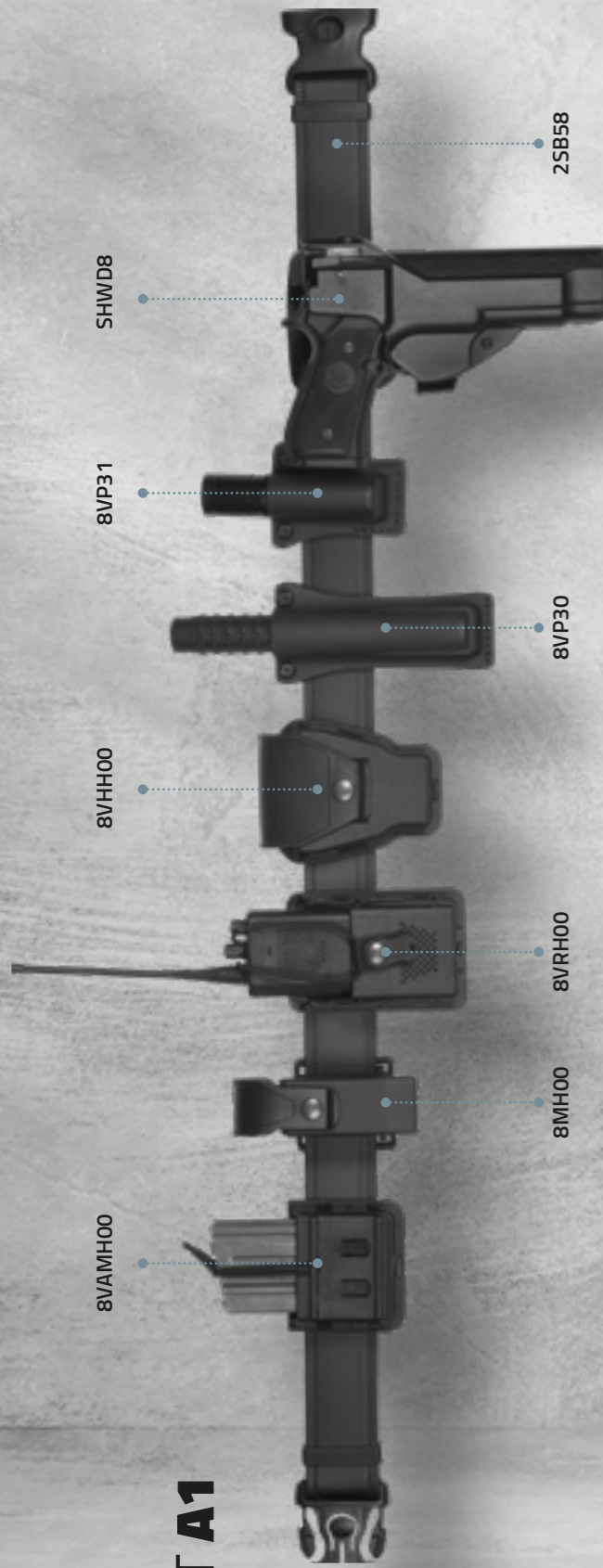

SET A2

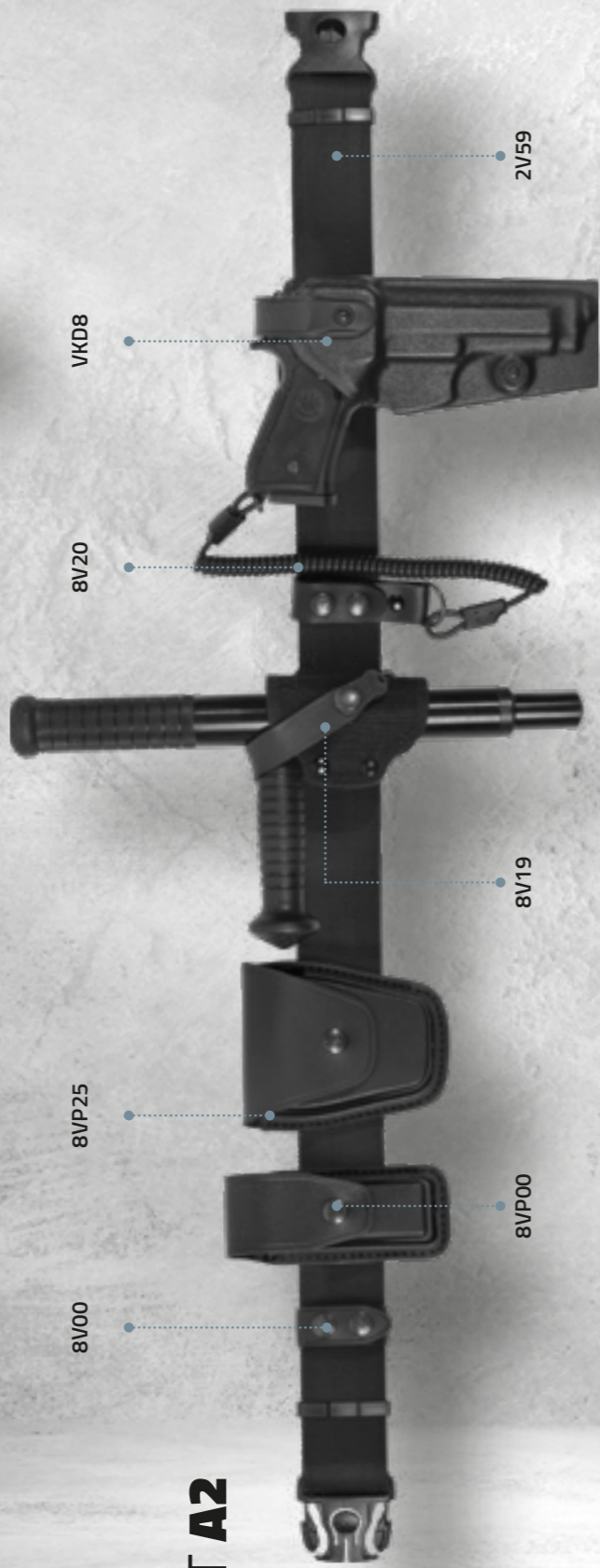

SET A3

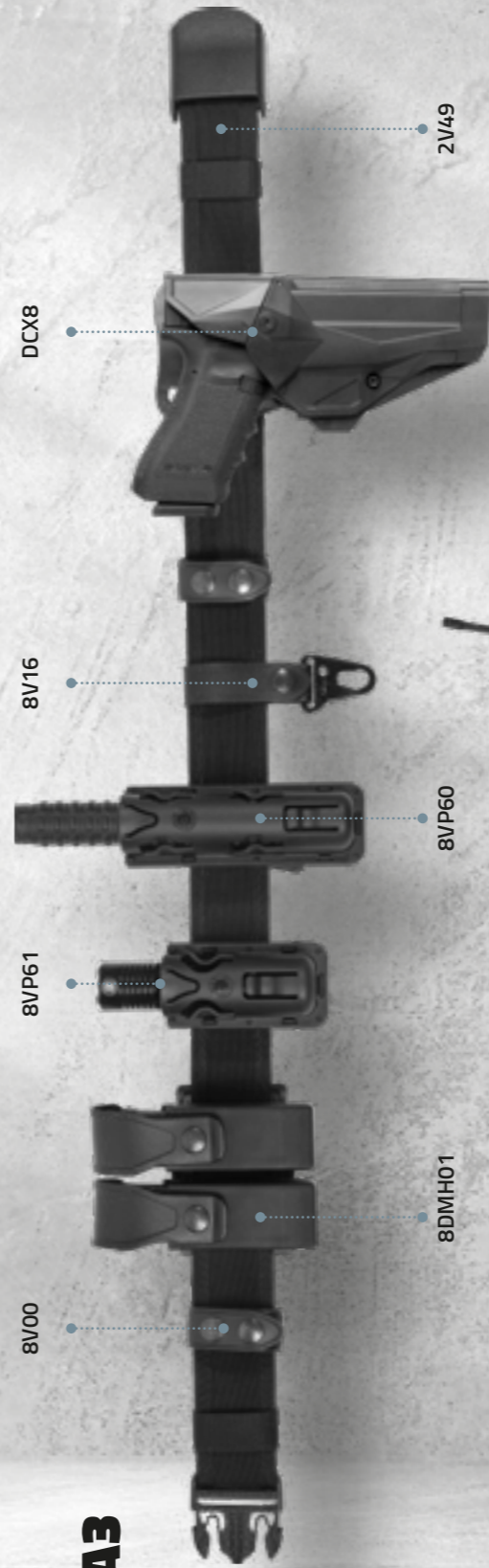

SET A4

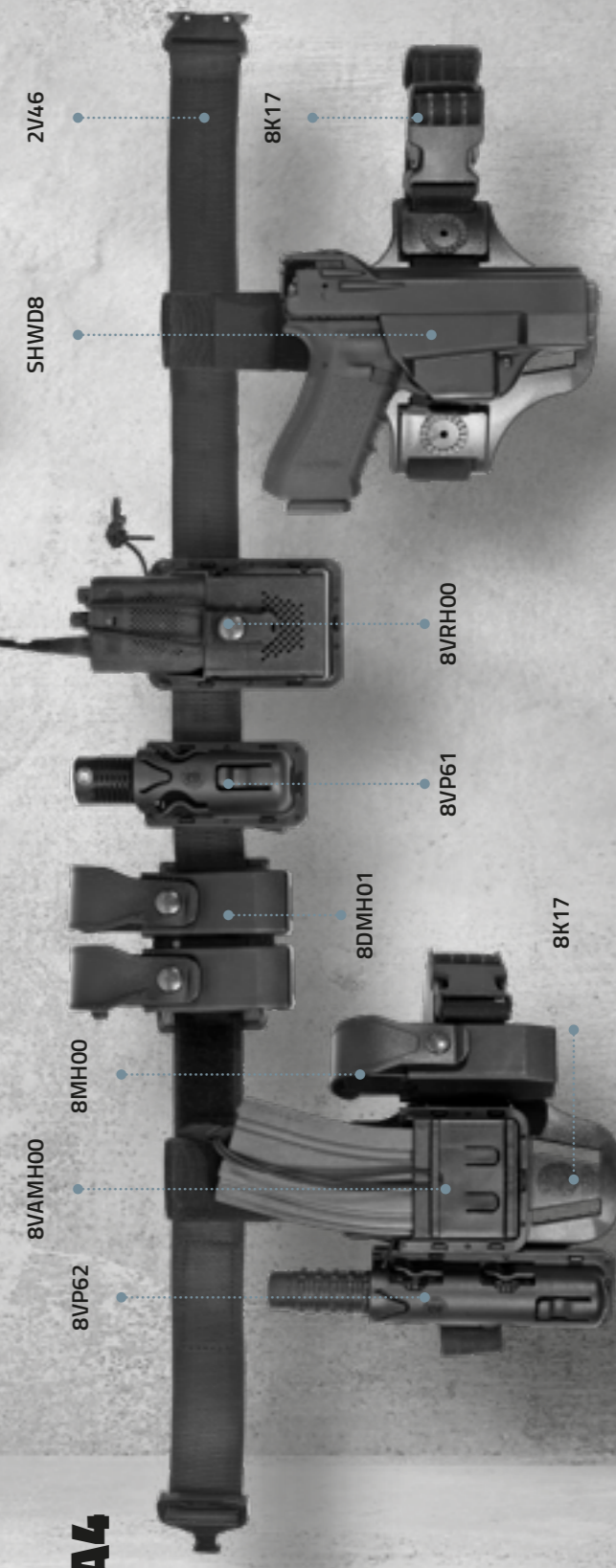

TACTICAL **T**

CONCEALMENT **C**

SPORT **S**

GLOVES **G**

+

GUIDE



DUTY > NYLON HOLSTERS

series **SP2**

POLICE/DUTY CORDURA BELT HOLSTER

3 safety systems: automatic pull side and thumb snap. Polymer belt loop with 3 different inclinations.

AVAILABLE FOR

Beretta APX, 92/98/PX4 -**Glock** 17/22/19/23/31/32/45/47 -**H&K** P30/VP9/SFP9, USP, USP Compact, P2000 -**Sig Sauer** 2022/P220/226/228/229 -**Walther** P99



series **FP2**

THERMO MOLDED BELT CORDURA HOLSTER.

Adjustable quick release with safety "Vega Stop Snap" system, polymer belt support distant from the body, vertical positions with different inclinations.

AVAILABLE FOR

-**Beretta** APX, 92/98, 84, 8000, PX4 -**Colt** Python 4", King Cobra 4", all 1911's Rail and NO Rail -**Glock** 17/19/22/23/31/32/45/47 -**H&K** USP, USP Compact, P2000 -**Ruger** GP100 4" -**Sig Sauer** P320, P220, 226, 228, 229, 2022 -**Springfield** 1911's -**S&W** K Frame 4", L Frame 4" -**Tanfoglio** GT21, Force -**Taurus** PT92 -**Walther** P99, PPQ, P99Q -**H&K** P30/VP9/SFP9 -**FN** Five Seven N, CZ SP01 -**Caracal** F and CS&W M&P M2.0 5"



DUTY > NYLON HOLSTERS

series **PR2**

HOLSTER IN NYLON/CORDURA PADDED AND REINFORCED WITH PE AND POLYMER

Inner lining for a better weapon protection. Upper safety system with front adjustable rotating lace through three holes. Possibility of locking the rotating lace by means of a sliding mechanism to impede downward movement. It can be used with or without internal shield (both components are included). Polymer core for greater resistance and durability.

Polymer swivel BELT LOOP, allow angle turn by a simple lever pressure.

AVAILABLE FOR

Beretta APX, 92/98/PX4/90/90Two/98 A1 -**Glock** 17/19/22/23/31/32/37/38/45/47 -**H&K** USP Compact, VP9/SFP9 -**Sig Sauer** P226 (Rail included), P320 -**Tanfoglio** Police/Force/Pro -**CZ** SP01 -**Caracal** F and C -**S&W** M&P M2.0 5" and 4"



series **PC2**

QUICK RELEASE HOLSTER

Duty cordura holster, "Pull Forward" Safety System, adjustable and amovable quick release. Polymer belt support distant from the body, vertical positions with different inclinations. Possibility to insert the thigh system kit optional 2K12.

AVAILABLE FOR

Beretta 92/98, 84, PX4 -**CZ** 75/85 -**Glock** 17/19/20/21/22/23/31/32/45/47 -**H&K** USP, USP Compact, P2000 -**Sig Sauer** P220 / 225 / 226 / 228 / 229 / 2340 / 2009 / 2022 -**S&W** Auto 4" -**Tanfoglio** Force, Force Carry -**Taurus** PT92 -**Walther** P99





DUTY > NYLON HOLSTERS

series **P2**

BELT HOLSTER WITH VEGA STOP SNAP SAFETY SYSTEM

Adjustable safety lace with Vega Stop Snap mechanism. Polymer belt loop.

AVAILABLE FOR

Beretta APX, 92/98, 84, 8000, 9000, PX4, 90TWO -**CZ** 75/85, 83, SP01 -**Colt** Government -**Glock** 17/19/20/21/22/23/30/31/32/45/47 -**H&K** USP, USP Compact, P2000, P30, VP9/SFP9 -**Sig Sauer** P220/225/226/228/229/320/2340/2009/2022 -**Springfield** all 1911 S, XD -**Tanfoglio** Force, Force Carry, Police, Pro -**Taurus** PT92, 24/7 -**Walther** P99, PP, PPQ, P99Q -**FN** Five Seven N -**Caracal** F and C -**S&W** M&P M2.0 5" and 4", Auto 3 1/2", 4"



series **PH2**

HOLSTER WITH QUICK RELEASE SYSTEM AND VEGA STOP SNAP SAFETY MECHANISM

Holster in Nylon/Cordura padded and reinforced with PE and polymer. Inner lining for a better weapon protection. Adjustable straps to accommodate different weapons. Nylon/Cordura belt loop lined and padded for greater comfort.

AVAILABLE FOR

Beretta APX, 81/84/92/98/PX4/90/90Two/98 A1 -**Colt** 1911 e cloni (Rail Included) -**Glock** 17/19/20/21/22/23/31/32/37/38/45/47 -**H&K** VP9/SFP9, P30/USP stand. And Compact. -**Sig Sauer** P320, P226 (Rail included)/P250/2022 -**Tanfoglio** Police/Force/Pro -**Walther** P99/PPQ/P99Q -**FN** Five Seven N -**CZ** SP01 -**Caracal** F and C -**Revolver** S&W 3" and 4" K & L Frame -**S&W** M&P M2.0 5" and 4"



DUTY > NO LETHAL WEAPONS NYLON HOLSTERS

series **PN2** "JPX NYLON DUTY HOLSTER"

NYLON BELT HOLSTER

Adjustable thumb snap safety lace. Strong nylon belt loop.

AVAILABLE FOR

-**Piexon** JPX4



series **TN2** "TASER X2 NYLON HOLSTER"

NYLON BELT HOLSTER

Adjustable Index snap safety lace. Strong nylon belt loop to fix the holster on the belt and on the MOLLE system.

AVAILABLE FOR

-**Taser** X2



DUTY	D
TACTICAL	T
CONCEALMENT	C
SPORT	S
GLOVES	G
	+
	GUIDE



series
M2

CORDURA HOLSTER REINFORCED WITH POLYMER INSERT

Flap velcro closure, polymer belt loop with double snaps. Possibility to insert the safety lace. Optional Kit thigh system 2K10.

AVAILABLE FOR
L/Auto - L/Auto Compact - M/Auto - Rev. 4", 6", Desert Eagle



series
SA26

CORDURA BELT FLAP HOLSTER
Cordura belt flap holster with snap closure.

DISPONIBILE PER / AVAILABLE FOR
SA260 per L/Auto - SA261 per M/Auto
SA262 per L/Auto Compact



series
LM2

ADJUSTABLE CORDURA TACTICAL HOLSTER

For pistol with flashlights or laser, ambidextrous, reinforced with polymer insert, quick release flap, movable steel belt loop, belt loops for 4cm. belt use, barrel cleaning stick inserted in front side, possibility to insert the quick release (included). Possible optional: thigh kit item 2K13.

AVAILABLE FOR
L/Auto - L/Auto Compact



series
MB2

CORDURA MILITARY HOLSTER REINFORCED WITH POLYMER INSERT

Cordura military ambidextrous holster reinforced with polymer insert, quick release flap, amovable steel belt loop, belt loops for 4 cm belt use, barrel cleaning stick inserted in front side, possibility to insert the quick release (included). Possible optional: thigh kit item 2K13 and shoulder kit 2K11.

AVAILABLE FOR
L/Auto - L/Auto Compact



series
MB220L

CORDURA MILITARY HOLSTER REINFORCED WITH POLYMER INSERT

Same characteristics of MB2 holster but with the complete cover of the pistol grip.

AVAILABLE FOR
L/Auto



cod.
2K13

THIGH KIT FOR ITEMS LM2, MB2, MB220L





DUTY > NYLON ACCESSORIES

cod.
2FP00

TWO ROW MAGAZINE CASE IN THERMO-MOLDED NYLON
Polymer tip for rapid release. Polymer belt loop adjustable by velcro with non-slip system.



cod.
2FP03

TWO ROW DOUBLE MAGAZINE CASES
Polymer tip for rapid release. Horizontal and vertical position polymer belt loop.



cod.
2FP25

HANDCUFFS CASE STANDARD TYPE
Chain in thermo-molded nylon. Polymer tip for rapid release. Polymer belt loop adjustable by velcro with non-slip system.



cod.
2FP24

THERMO MOLDED NYLON LARGE HANDCUFFS HOLDER
Snap closure. For Handcuffs as LIPS



cod.
2FP05

RADIO CASE IN THERMO-MOLDED NYLON
Polymer tip for rapid release. Adjustable lace in tubular elastic. Polymer belt loop with swivel system.



cod.
2FP30

RETRACTABLE 21" BATON CASE IN THERMO-MOLDED NYLON
Polymer tip for rapid release. Polymer belt loop adjustable by velcro with non-slip system. Lower aperture for use when extended.



cod.
2FP31

For Flashlights

cod.
2FP32

For COS

THERMO MOLDED NYLON HOLDERS
Polymer tip for rapid release.



cod.
2FP06

THERMO MOLDED NYLON MULTI-TOOLS HOLDER
Polymer tip for rapid release.



DUTY > NYLON ACCESSORIES

cod.
2P50

NYLON MAGAZINE CASE
Adjustable nylon belt loop.



cod.
2P49

POCKET MAGAZINE CASE
No slip band.



cod.
2P55

NYLON DOUBLE MAGAZINE HOLDER
Plastic belt loop. Horizontal or vertical positions. Retention screws.



cod.
2P79

NYLON MAGAZINE/KNIFE HOLDER AND FLASHLIGHT HOLDER
Elastic flashlight loop, webbing belt loop.



cod.
2P51

NYLON DOUBLE MAGAZINE CASE
Nylon belt loop.



cod.
2G63

MAGAZINE AND HANDCUFFS HOLDER
Nylon belt loops.



cod.
2P59

NYLON DOUBLE MAGAZINE HOLDER
Plastic belt loop. Horizontal or vertical positions. Retention screws.



cod.
2P14

NYLON SPEEDLOADER POUCH
Adjustable nylon belt loop.



cod.
2P83

NYLON DOUBLE LATEX GLOVE POUCH
With webbing belt loop.



cod.
2V23

PISTOL SAFETY LACE
Rotative buckle safety lanyard.



cod.
2V20

PISTOL SAFETY LACE
With molten terminal.



cod.
2V22

PISTOL SAFETY LACE
With molten terminal.





DUTY > NYLON ACCESSORIES

cod. **2P75**

NYLON HANDCUFFS HOLDER
Nylon handcuffs case with belt loop with snaps.



cod. **2V25**

KEY HOLDER
Metal hook key holder.



cod. **2P76**

NYLON HANDCUFFS HOLDER
Nylon handcuffs case with nylon belt loop.



cod. **2V16**

KEY HOLDER
With plastic spring clip.



cod. **2P73**

NYLON HANDCUFFS HOLDER
Handcuff case France/Lips type.



cod. **2V00**

NYLON BELT KEEPER
With double snaps.



cod. **2P77**

OPEN NYLON HANDCUFFS HOLDER
Open nylon handcuffs case with safety snap.



cod. **2V02**

NYLON BELT KEEPER
With hidden handcuffs key.



cod. **2R00**

UNIVERSAL NYLON RADIO CASE
With adjustable closure, double snaps belt loop.

Size: L



cod. **2R03**

UNIVERSAL NYLON RADIO CASE
Adjustable elastic strap.

Size: M



cod. **2R01**

UNIVERSAL RADIO CASE
Removable polymer belt loop.

Size: S



DUTY > NYLON ACCESSORIES

series **2R2**

NYLON CELLULAR PHONE CASE
Adjustable velcro fastening flap.

SIZES
2R24 cm 9x6x2
2R25 cm 12x7x2
2R26 cm 14x7,5x2
2R27 cm 14x8,5x2
2R28 cm 17x7x2
2R20 cm 16x6x3



series **2R3**

NYLON SHOULDER KIT
Nylon shoulder kit with single magazine case suitable for F02, A2.

SIZES
2R30 cm 15x6x3
2R31 cm 14x5x2,5
2R33 cm 11x5x2,5
2R34 cm 9x6x2,5



cod. **2G13**

WRITE PAD POCKET
External general pockets with velcro closure. Nylon belt loop.

SIZES
H15 x L2,5 x P2 cm



cod. **2G66**

MULTI-PURPOSE HAND-BAG FOR A CARTRIDGE BELT
Ideal for carrying all daily use objects directly on the cartridge belt (notepads, pens, keys, batteries, utility knife and other items).

SIZES
L18 cm x W12 cm x D5 cm



cod. **2R40**

UNIVERSAL NYLON SMARTPHONE CASE
Adjustable elastic strap.



series **2G**

NYLON PADDED UTILITY POUCH
With velcro closure.

SIZES
cod. **2G68**: SIZES L 14x16x3,5 cm
cod. **2G69**: SIZES M 11x14x3,5 cm
cod. **2G70**: SIZES S 13x12x3,5 cm



cod. **2G62**

NYLON MULTI UTILITY BAG

SIZES
L 10,5x H 12,5x P 3,5 cm



DUTY **D**

TACTICAL **T**

CONCEALMENT **C**

SPORT **S**

GLOVES **G**

+

GUIDE



DUTY > NYLON ACCESSORIES

cod. **2P78**

SPRAY76 ML CORDURA HOLDER
Webbing belt loop.

SIZES cm 13x4x3



cod. **2P81**

NYLON FLASHBANG HOLDER
With webbing belt loop.

SIZES cm 14x5x5



cod. **2P61**

NYLON MULTY TOOLS POUCH
Velcro closure.

SIZES cm 16x2x3,5



cod. **2P66**

cod. **2P68**
NYLON LIGHTS AND SPRAY HOLDER

2P66 14x4x4 for RSG4 and similar
2P68 for VL01 Light and similar



cod. **2P67**

NYLON EXPANDABLE BATON HOLDER 21"
With velcro closer.



cod. **2P65**

EXPANDABLE 21" BATON NYLON HOLDER
Webbing loop.

SIZES cm 21x4x2



cod. **2P84**

NYLON FLAHLIGHT D CELL HOLDER
With flap closure.



cod. **2P85**

NYLON FLASHLIGHT TYPE
Megalight AAA.

SIZES cm 16xØ1,7



cod. **2SM22**

UNIVERSAL FLASHLIGHT CASE
Modular system or belt use. Adjustable velcro lids. Adjustable velcro bands system.



cod. **2V10**

BATON, FLASHLIGHT C/CELL HOLDER
With plastic ring.



cod. **2V13**

FLASHLIGHT D/CELL HOLDER
With plastic ring



cod. **2V17**

SILENT KEYS RING
In nylon with velcro closure.



cod. **2V18** HORIZONTAL USE

cod. **2V19** VERTICAL USE

Adjustable ribbon Gloves Holder.

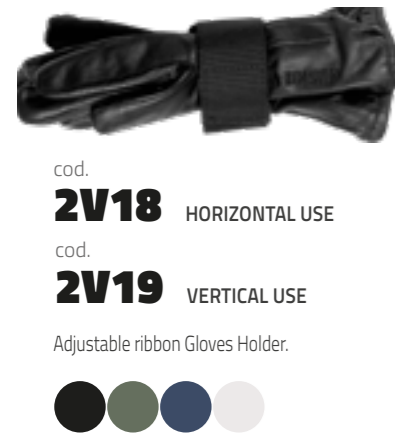

cod. **2G10** 2G11

CM 20X12X11 CM 21X15X13

ALL USES FOLDABLE NYLON BELT POCKETS
With velcro closure and adjustable elastic ring.



DUTY > NYLON ACCESSORIES

cod. **2GC50**

NYLON SHOTGUN CARTRIDGE POUCH
6 elastic loops.
Adjustable nylon belt loops.



cod. **2P54**

NYLON OPEN SHOTGUN CARTRIDGE POUCH
Nylon open shotgun cartridge pouch with 6 elastic loops.



cod. **2V43**

CARTRIDGE BELT FOR RIFLE
With elastic cells.



cod. **2GC52**

NYLON RIFLE CARTRIDGE POUCH
7 elastic loops.
Adjustable nylon belt loops.



cod. **2G60**
for shotgun cal. 12

cod. **2G61**
for rifle

BUTT STOCK SHELL HOLDERS
Butt stock shell holders, elastic cartridges loops.
Available for Right and Left side.



cod. **2V62**

CARTDRIGES NYLON BELT
Elastic loops.



cod. **2G65**

BUTT STOCK MAGAZINE CARRIER
AR70/90, M16 butt stock magazine carrier, elastic retention, adjustable flap, double adjustable laces with velcro clousure.



adjustable only one size

adjustable only one size



SET B1

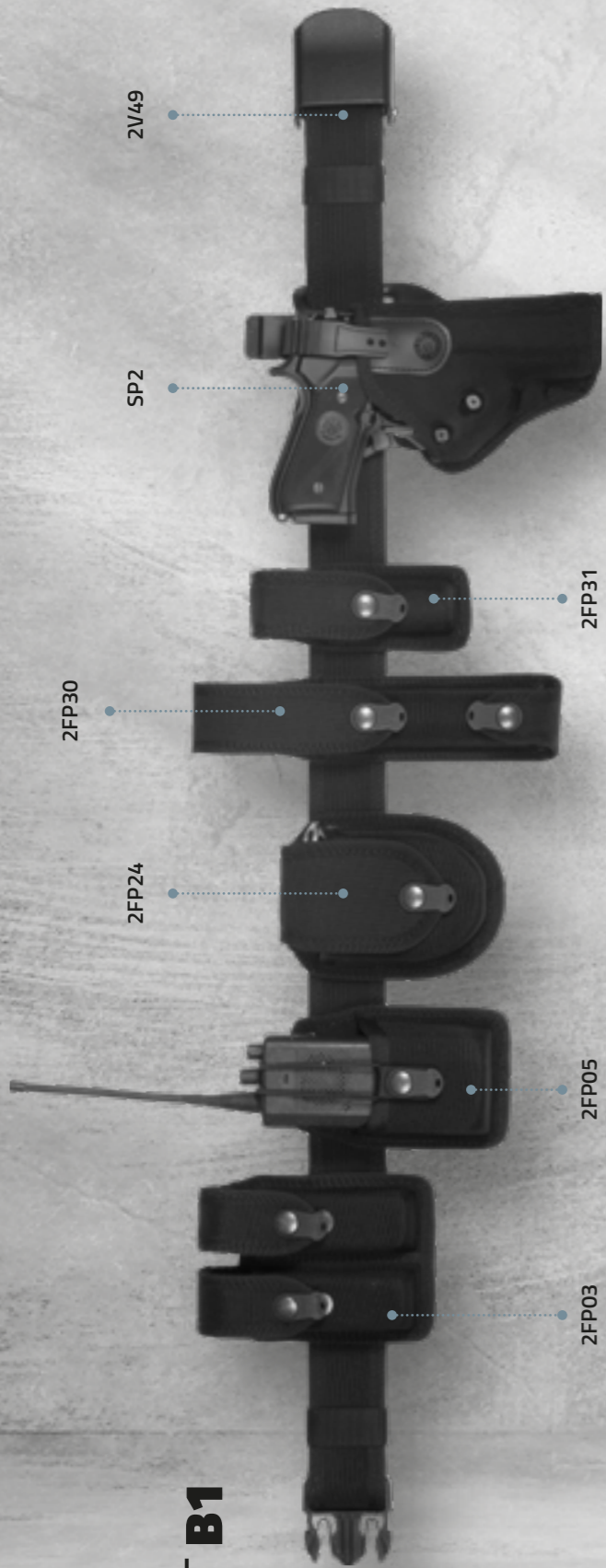

SET B2

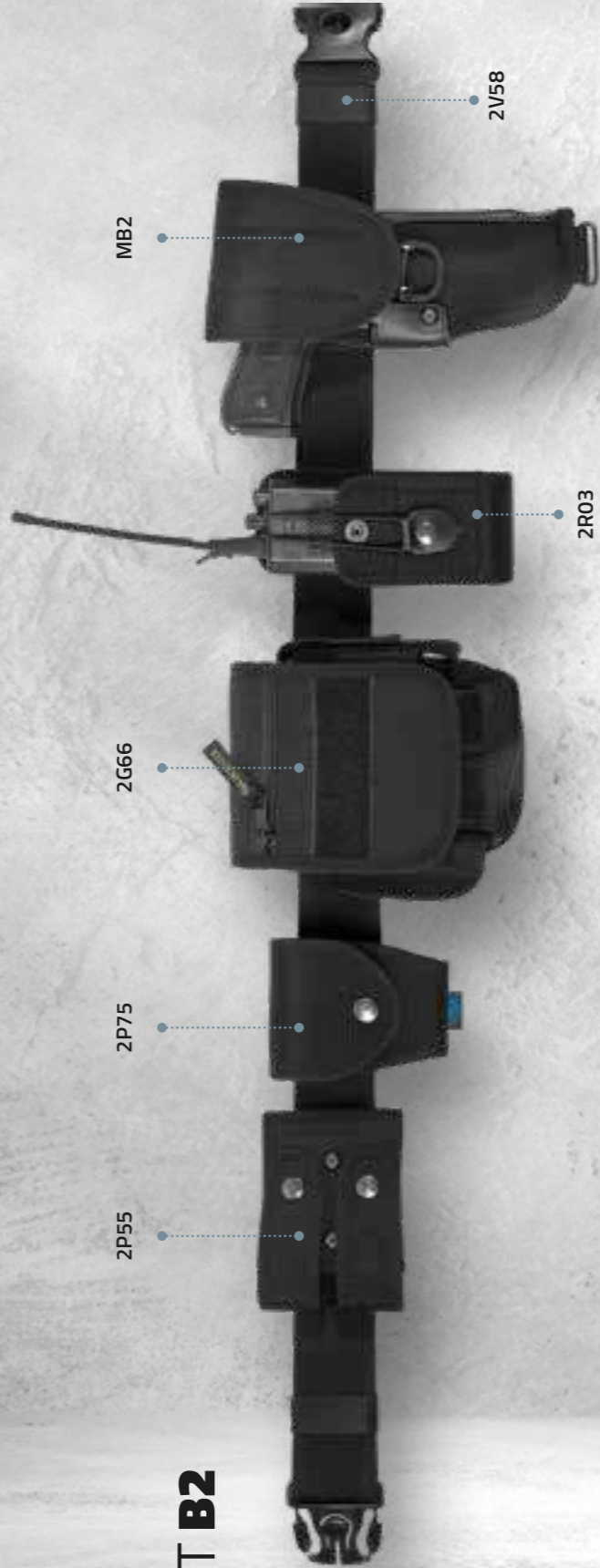

SET B3

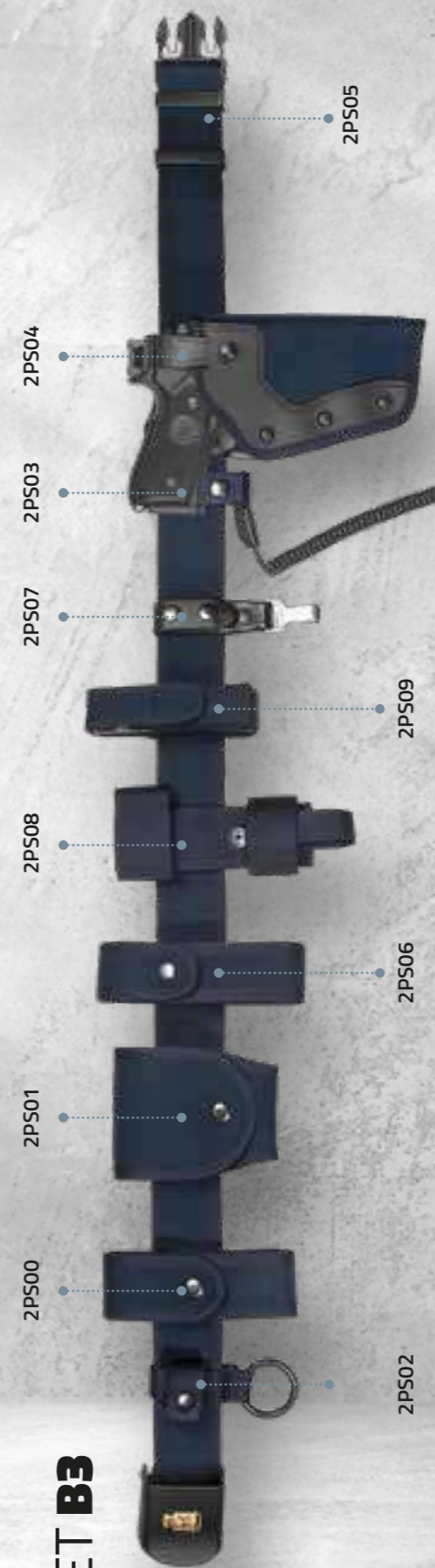

SET B4

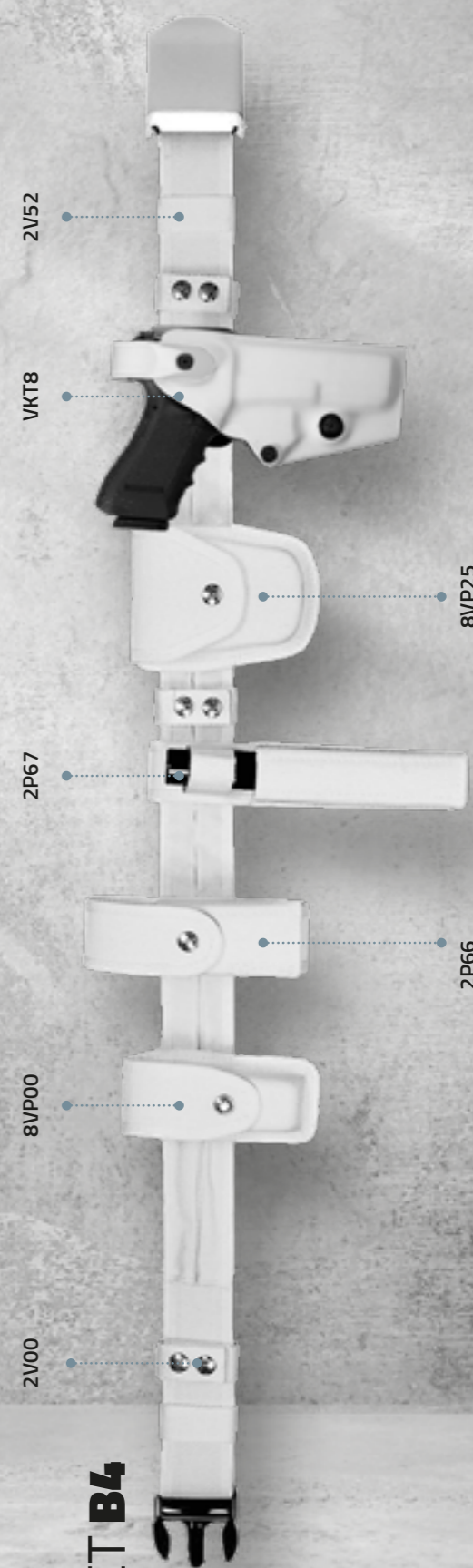

series
SP1

POLICE/DUTY BELT LEATHER HOLSTER

3 safety systems: automatic pull side and thumb snap. Polymer belt loop with 3 different inclinations.

AVAILABLE FOR
Beretta 927987PX4 -Glock 17/22/19/23/31/32/45/47 -H&K USP, USP Compact, P2000 -Sig Sauer 2022 -Walther P99

SAFETY GRADE 3



series
PR1

LEATHER DUTY HOLSTER

Upper safety system with front adjustable rotating lace through three holes. Possibility of locking the rotating lace by means of a sliding mechanism to impede downward movement. It can be used with or without internal shield (both components are included). Polymer core for greater resistance and durability. Polymer swivel BELT LOOP, allow angle turn by a simple lever pressure.

AVAILABLE FOR
Beretta APX, 92/98/PX4/90/90Two/98 A1 -Glock 17/19/22/23/31/32/37/38/45/47 -H&K USP Compact, VP9/SFP9 -Sig Sauer P226 (Rail included), P320 -Tanfoglio Police/Force/Pro -CZ SP01 -Caracal F and C -S&W M&P M2.0 5" and 4"

SAFETY GRADE 2



series
PP1

LEATHER HOLSTER SUITABLE FOR PROFESSIONAL POLICE USE

Leather support with Polymer inside reinforce.
Rapid release. Inclined position.

AVAILABLE FOR
Beretta 92/98, PX4 -Glock 17/19/22/23/31/32/45/47 -H&K USP Compact, P30 -Walther P99, PPQ -Tanfoglio Force, Police -Taurus PT92

SAFETY GRADE 1



series
P1

DUTY BELT HOLSTER WITH QUICK RELEASE

Duty leather belt holster, quick release, right side inclination position.

AVAILABLE FOR
Beretta 92/98, 84, 8000, 9000, PX4, 90TWO -Colt Government, Python 4", King Cobra 4" -CZ 75,85 -Glock 17/19/20/21/31/32/45/47 -H&K USP, USP Compact, P2000, P30 -Ruger GP100 4" -Sig Sauer P220,226,228,229 -S&W Auto 3 1/2" 4", K Frame 4", L Frame 4", N Frame 4" -Springfield 1911's -Tanfoglio GT21, Force, Police, Pro -Taurus PT92

SAFETY GRADE 1



P1 revolver



P1 Auto

series
PB1

DUTY HOLSTER WITH RETENTION SCREW

Duty leather belt holster. Quick release and retention screw. Belt loop support, inclination on the right side position.

AVAILABLE FOR
Beretta 92/98, 84, 8000, 9000, PX4, 90TWO, APX -Colt Government, Python 4" King Cobra 4" -CZ 75,85 -Glock 17/19/20/21/31/32/45/47 -H&K USP, USP Compact, P2000 -Ruger GP100 4" -Sig Sauer P220,226,228,229, 2340 -S&W Auto 3 1/2" 4", K Frame 4", L Frame 4", N Frame 4" -Springfield 1911's -Tanfoglio GT21, Force -Taurus PT92 -Walther P99

SAFETY GRADE 1



PB1 revolver



PB1 Auto



DUTY > LEATHER FLAP HOLSTERS

cod.
S100

LEATHER BELT FLAP HOLSTER
Leather belt flap holster, amovable double spring clip belt support

AVAILABLE FOR
Beretta 92/98



series
SB1

LEATHER BELT FLAP HOLSTER
Leather belt flap holster, amovable double spring clip belt support

AVAILABLE FOR
Beretta 92/98,81,84,8000 -Glock 17, 19, 22, 23 -Tanfoglio GT21, Force, Police, Pro -Taurus PT92 -Walther P99



series
SC1

LEATHER BELT FLAP HOLSTER
Leather belt flap holster, amovable double snap belt support. Magazine case.

AVAILABLE FOR
Beretta 81, 84, 85



series
SA1

LEATHER BELT FLAP HOLSTER
Leather belt flap holster. Leather belt support.

AVAILABLE FOR
Beretta 92/98, 84, 8000, 9000 -Glock 17,19,22,23 -Tanfoglio GT21, Force, Police, Pro -Taurus PT92 -Walther P99



DUTY > LEATHER ACCESSORIES

cod. **1P00** cod. **1P01**
LEATHER MAGAZINE CASE WITH TWO SNAPS
1P00 double row
1P01 single row.



cod. **1P15**
LEATHER MAGAZINE CASE
Cal. 45 with two snaps.



cod. **1P03**
LEATHER DOUBLE MAGAZINE CASE WITH TWO SNAPS
Orizzontal or vertical position.



cod. **1P24**
LEATHER HANDCUFFS CASE
With multi uses front pouch.



cod. **1P25**
LEATHER HANDCUFFS CASE



cod. **1P26**
LEATHER OPEN HANDCUFFS CASE





DUTY > LEATHER ACCESSORIES



cod. **1P05**

OPEN LEATHER MAGAZINE CASE
With elastic retention.



cod. **1P29**

COMPACT SINGLE MAGAZINE CASE
Without stitching.
Retention screw.



cod. **1P30**

COMPACT DUAL MAGAZINE CASE
Without stitching.
Horizontal or vertical position.



cod. **1P27**

LACE HANDCUFFS CASE
With safety snaps.



cod. **1P07**

LEATHER HANDCUFFS AND
MAGAZINE CASES
with retention screws.



cod. **1P10**

LEATHER CARTRIDGE POUCH
6 cartridges cal. 38/357 pouch.



cod. **1P14**

LEATHER SPEEDLOADER POUCH
Cal. 38/357.



cod. **1P11**

LEATHER CARTRIDGE POUCH
6 cartridges cal. 38/357 pouch.



cod. **1P12**

LEATHER CARTRIDGE POUCH
6 cartridges cal. 38/357 pouch.



DUTY > LEATHER ACCESSORIES

cod. **1V16**

LEATHER KEY HOLDER
WITH SPIRAL RING



cod. **1V03**

SQUARE RING BELT LOOP
FOR HOLSTERS



cod. **1V12**

ONE CATCH BELT LOOP FOR HOLSTERS



cod. **1V05**

DOUBLE CATCHES BELT LOOP
FOR HOLSTERS



cod. **1V15**

LEATHER KEYS HOLDER



cod. **1V20**

PISTOL SAFETY LACE
with leather belt loop

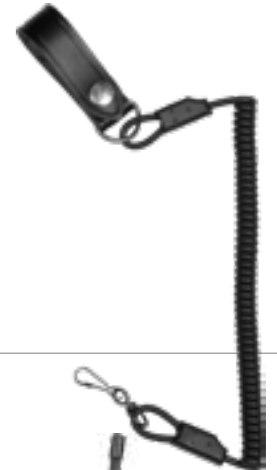

cod. **1R00**

UNIVERSAL LEATHER RADIO CASE
Adjustable safety lace. Double belt loop system (with clip and with holes).

SIZES cm 14,5x5,5x3,5



cod. **1R10**

UNIVERSAL LEATHER RADIO CASE
With elastic retention strap.

SIZES cm 19x7,5x4,5



cod.
1V10

BATON/FLASHLIGHT
C/CELL HOLDER



cod.
1V30

LEATHER FLASHLIGHT AAA
CELL HOLDER

Sizes cm Ø 1,5



cod.
1V00

LEATHER BELT-KEEPER
WITH TWO SNAPS



cod.
1V13

FLASHLIGHT D/CELL HOLDER



cod.
1V31

LEATHER FLASHLIGHT AA
CELL HOLDER

Sizes cm Ø 1,8



cod.
1V01

TWO HOLES LEATHER
BELTKEEPER



cod.
1V33/34

LEATHER FLASHLIGHT SURFIRE/
WALTHER HOLDER
1V34
for Key Defender Spray.



cod.
1V32

FLASHLIGHT C/D CELL
HOLDER

Sizes cm Ø 4



cod.
1V02

LEATHER BELTKEEPER
WITH HANDCUFFS KEY



cod.
1V24 "PR24 HOLDER"

LEATHER TONFA BATON HOLDER
Designed to hold most popular Retrac.
Tonfa Baton models.
Safety lace with fast snap closure.
Openable belt loop, 360° rotative
with one fixed position.
Available for right and left hand.



cod.
1V25 "CC HOLDER"

LEATHER TONFA BATON
HOLDER
Designed to hold the most part of baton
models.
Safety lace with snap closure.
Adjustable long belt lace with plastic buckle.
Adjustable velcro system.



cod.
8V19 "MIX T-HOLDER"

TONFA HOLDER IN POLYMER
AND NYLON
With swivel loop.



cod.
8VP64 "TONFA MASK HOLDER"

INJECTION POLYMER TONFA BATON
HOLDER
Designed to hold the most part of baton models. Safety
rotating lace with safety snap. Openable and 360°
rotative belt loop.



DUTY > BIBS & ACCESSORIES FOR TRAFFIC CONTROL



cod. **4AV15/16**

HIGH VISIBILITY VEST
Double reflective stripes, two front pockets, radiocase, multiutility pocket. Available with personalized writings.
sizes: S, M, L, XL, XXL, XXXL



cod. **4AV04/05/11**

HIGH VISIBILITY BIBS
High visibility bibs with double reflective stripes, elastic sides retention with velcro closure. Available neutral (cod. 4AV04) or with personalized writings.
sizes: I (S/M), II (L/XL)



cod. **4AV01**

HIGH VISIBILITY SLEEVE
High visibility sleeve with two reflective stripes. Elastic retention.



cod. **4AV00**

REFLECTIVE CAP COVER
High visibility cap cover, two reflective stripes. Transparent window. Elastic retention.



cod. **5AR00**

REFLECTIVE WHITE CAP COVER
Reflective cap cover with transparent badge window and elastic retention.



cod. **4AV03**

HIGH VISIBILITY GAITERS
High visibility gaiters, two reflective stripes, zip closure.



cod. **4AV02**

HIGH VISIBILITY SHORT SLEEVE
High visibility short sleeve with transparent window. Velcro closure.



cod. **5AR01**

REFLECTIVE WHITE SLEEVE
Reflective white sleeve with elastic retention.



series **AP4**

GABARDINE BIBS
Elastic lace. Ask for available writings.



cod. **5AR04/09/15**

REFLECTIVE BIBS
Elastic lace. Available neutral (cod. 4AV04) or with personalized writings.
sizes: I (S/M), II (L/XL)



cod. **1V87**

LEATHER HANDBAG
Double compartments. Brass buckle closure. Available also with one compartment (cod. 1V86).
Size: cm 25 x 18



cod. **1V83**

LEATHER SHOULDER/HANDBAG
Brass buckle closure. Adjustable sling.
Size: cm 26 x 20



cod. **1V77**

LEATHER SHOULDER/HANDBAG
Brass buckle closure. Adjustable sling.
Size: cm 30 x 22

DUTY > ID BADGES & WALLETS



series **1WG**
SOFT LEATHER HORIZONTAL BADGE / ID WALLET
Various compartments, with removable badge holder. Ask for available badges.



series **1WE**
LEATHER HORIZONTAL BADGE / ID WALLET
Various compartments, with removable badge holder. Ask for available badges.



series **1WD**
LEATHER BADGE / ID WALLET
Various compartments, with removable badge holder. Ask for available badges.



series **1WF**
UNIVERSAL LEATHER ID / BADGE HOLDER
With chain.



series **1WL**
LEATHER BADGE / ID WALLET
Magnet closure, double uses:
1) As standard wallet.
2) On the neck by chain.



series **1WB**
LEATHER BADGE HOLDER
Two uses: with chain or belt loop. Ask for available badges.



series **1WA**
LEATHER BADGE HOLDER
With belt clip. Ask for available badges.



"BADGES ARE NOT FOR SALE"



SET C1

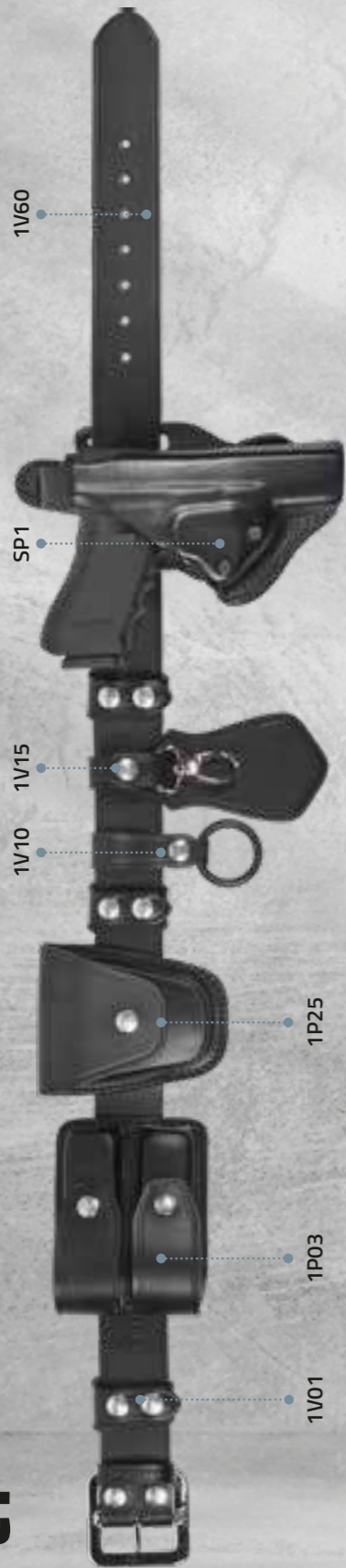

SET C2

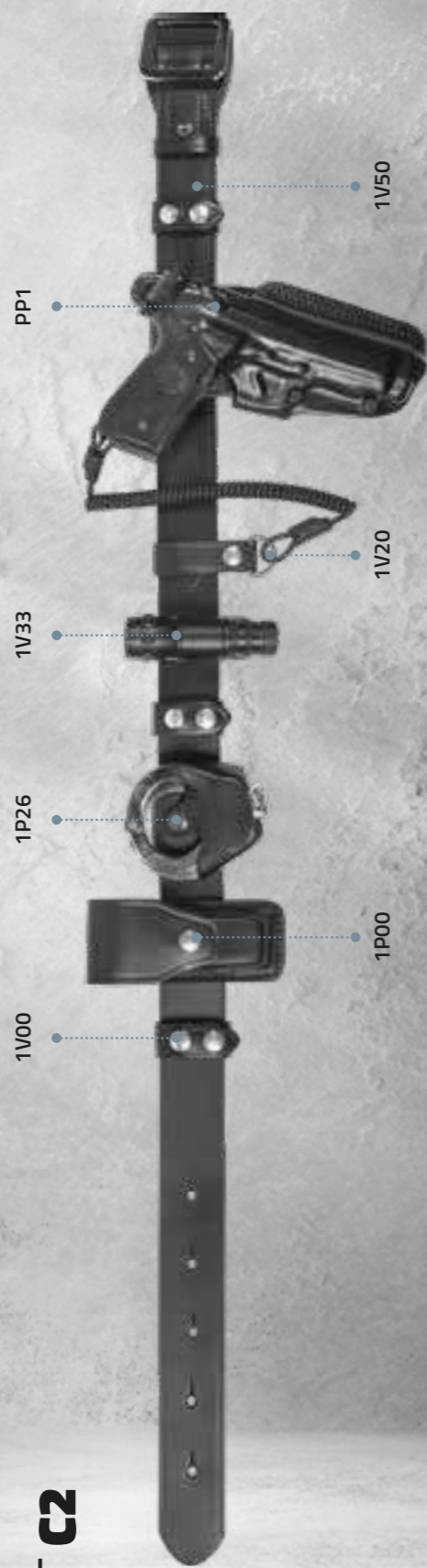

SET C3



SET C4

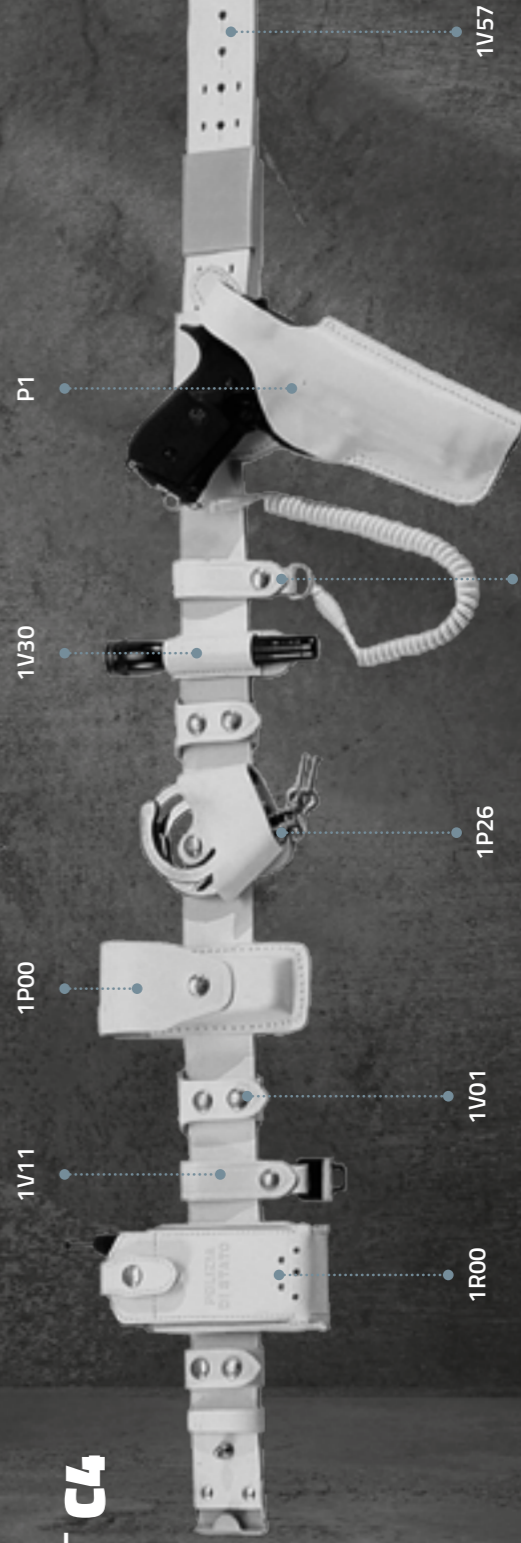

TACTICAL **T**

CONCEALMENT **C**

SPORT **S**

GLOVES **G**

+

GUIDE

cod.

2V58

NYLON PADDED BELT

PE inside for a better comfort.
Adjustable double sides by velcro system.
Under belt cod. 2V54 compatible.
sizes adjustable with velcro: I, II, III, IV



cod.

2V31

NYLON PROFESSIONAL BELT

With a polymer core for greater resistance to torsion.
Inside padded and thermo-molded for greater aeration and comfort.
Velcro adjustment on the sides.
Safety 3 points buckle.

sizes: S, M, L, XL



cod.

2V49

NYLON BELT WITH POLYMER INNER STRUCTURE

Safety buckle with flip open system.
Under belt compatible 2V61.
Available with 3 push-buttons safety buckle (cod. 2V49S).
Available in blue with Police buckle (cod. 2V48).

H cm 5 - sizes: S, M, L, XL



cod.

2V52

NYLON BELT WITH POLYMER INNER STRUCTURE

Nylon safety buckle with flip open system.
Double long holes for plastic handcuffs.
Suitable underbelt (cod. 2V61).
Available also with 3 points safety buckle (cod. 2V52S).

H cm 5 - sizes: S, M, L, XL



cod.

2V59

EXTRA RIGID NYLON BELT

3 way safety buckle.
Suitable cod. 2V54 under belt.

sizes adjustable with velcro: I, II, III



cod.

2V56

DOUBLE WEBBING EXTRA RIGID BELT

Double webbing extra rigid belt with inside polymer.
Inner velcro hook to attach the under belt.
Adjustable by velcro system.
3 way safety buckle.
Under belt compatible cod. 2V65/2V61.

H cm 5 - sizes: S, M, L, XL



cod.

2V65

PADDED UNDERBELT

Padded underbelt with outer part in female velcro.

H cm 4 - Taglie/Sizes: S/M/L/XL



cod.

2V54

NYLON UNDER BELT

Front side in velcro male. Adjustable velcro clousure.

sizes adjustable with velcro: S, M, L, XL



cod.

2V61

NYLON UNDER BELT

For belts type 2V52. Front side in velcro female.

Adjustable velcro clousure.

sizes adjustable with velcro: S, M, L, XL



cod.

2V63

NYLON BELT

Adjustable velcro clousure.

sizes: I, II, III



cod.

2V64

NYLON BELT

Adjustable velcro clousure with plastic ring.

sizes: I, II, III





cod
2V47

COBRA-D BELT
Polyamide double layer belt.
Adjustable by velcro system.
Cobra buckle with D ring integrated to use with
rope/hooks.

sizes adjustable with velcro: S, M, L, XL



cod.
2V45

WIDE EMERGENCY RESCUE BELT
In double nylon webbing.
Features dropforged parachuting spec buckle.

sizes adjustable with velcro: S, M, L, XL



cod.
2V41

INSTRUCTORS COBRA BELT
With Double nylon webbing with inside polymer reinforcement.
'Cobra' buckle, tested resistance up to 17.8 KN.

sizes adjustable with velcro: S, M, L, XL



cod.
2V46

EMERGENCY RESCUE COBRA BELT
Double webbing with triangle attach.
'Cobra' buckle, tested resistance up to 17.8 KN.

sizes adjustable with velcro: S, M, L, XL



cod.
2V42

EXTRA STRONG POLYAMIDE WEBBING BELT
Doubled for improved resistance with holster case and tactical accessories.
Outside adjustable velcro fastening.
With polymer Cobra Buckle.

sizes adjustable with velcro: S, M, L, XL



cod.
2V40

WIDE INSTRUCTORS NYLON BELT
In nylon webbing with polymer internal reinforcement.
Features drop-forged parachute specifications buckle.
Velcro adjustment.

sizes adjustable with velcro: S, M, L, XL



cod
2V66

SLIDER-BELT 40 MM
Polyamide double layer belt.
'Vega Slider' buckle.

sizes: S, M, L, XL



cod
2V67

SLIDER-BELT 45 MM
Polyamide double layer belt.
Vega slider buckle.

sizes: S, M, L, XL



DUTY > NYLON BELTS

cod. **2V32**
ULTRA CONFORT NYLON UNDERBELT
 Suitable for police, military or tactical use.
 Inside padded and thermo-molded for greater aeration and comfort.
 Easy fastening with adjustable velcro loops.
 available sizes: S, M, L, XL



cod. **2V44**
TACTICAL PADDED BELT
 With adjustable inner webbing belt, MOLLE system compatible.
 Available also with Cobra Buckle code **2V441**.
 available sizes: S, M, L, XL



cod. **2V33**
TACTICAL MOLLE BELT
 Adjustable reinforced webbing,
 MOLLE system compatible.
 available sizes: S, M, L, XL



cod. **2V30**
PADDED TACTICAL BELT
 For optimal comfort even when carrying heavy loads, the outer configuration subdivided into various apertures between the Molle platforms means even non Molle compatible holsters, thigh kits and pockets can be inserted directly to the belt loop.
 The waist belt has removable and adjustable braces, the crossover rear ring system provides elasticity and flexibility during any movement.
 The belt loop is made from sturdy nylon webbing and has a three way safety buckle.

available sizes: M, L, XL



VKX8 holster mount on 2V30



DUTY > LEATHER BELTS

cod. **1V50**
REINFORCED LEATHER DUTY BELT - H 5 CM
 One catch clousure
 sizes: S, M, L, XL



cod. **1V58**
REINFORCED LEATHER DUTY BELT H 5 CM.
 Two hooks clousure: knob plus two sub-buckle hooks.
 sizes: S, M, L, XL



cod. **1V57**
LEATHER DUTY BELT - H 5 CM
 Two hooks clousure: knob plus two sub-buckle hooks.
 Available also with box buckle gold or nichel colours. Available also with personalized buckle.
 sizes: S, M, L, XL



cod. **1V56**
LEATHER DUTY BELT - H 5 CM
 Two hooks clousure, rectangular buckle with double pinse.
 Available also with box buckle gold colour.
 sizes: S, M, L, XL



cod. **1V54**
LEATHER DUTY BELT - H 5 CM
 Adjustable shoulder strap. Available also with box buckle gold or nichel colours (item 1V63), in reflective fabric and with personalized buckle.
 sizes: S, M, L, XL



cod. **1V60**
LEATHER DUTY BELT - H 5 CM
 With one pinse. Available also with box buckle gold or nichel colours (item 1V63) in reflective fabric and with personalized buckle.
 sizes: S, M, L, XL



cod. **1V61**
LEATHER DUTY BELT - H 4 CM
 With one pinse.
 sizes: S, M, L, XL



cod. **1V51**
REINFORCED LEATHER DUTY BELT - H 4 CM
 Buckle with one pinse.
 sizes: S, M, L, XL



TACTICAL

TACTICAL
T

HOLSTERS AND ACCESSORIES FOR LAW ENFORCEMENT & MILITARY

- 76 / 81** T.A.C.S. LINE
- 82 / 89** POLYMER THIGH HOLSTERS
- 90 / 91** POLYMER LIGHT THIGH HOLSTERS
- 92 / 95** NYLON HOLSTERS
- 96** VESTS
- 97** CHEST/ THIGH CARRY SYSTEMS
- 98 / 99** MODULAR SYSTEMS
- 100** THIGH MAGAZINE POUCHES
- 101** ACCESSORIES
- 102** RUCKSACKS
- 103** HYDRATION SYSTEMS
- 104 / 107** CARGO BAGS
- 108 / 109** BLACK LABEL LINE
- 110** GUN CASES
- 111 / 112** TACTICAL SLINGS
- 113** RIOT CONTROL KIT
- 114 / 115** BALACLAVA & PROTECTIONS



T.A.C.S

Tactical Adaptable Carrier System



DUTY
TACTICAL
CONCEALMENT
SPORT
GLOVES
+

GUIDE



cod.
8BL00 "BUNGY L/AUTO"

INJECTION MOLDED RUBBERISED POLYMER HOLSTER

Adjustable through a TUBULAR ELASTIC system for an easy fit of all L/Auto and L/Auto compact weapons on the market. Removable lock system, through a tubular elastic, which can be inserted on the weapon grip or on the upper part of the weapon hammer. Ambidextrous, mounted with a loop that can be opened for customizing both height and tilt through 2 or 3 screws. The adjustable passage permits use on belts with different heights and on MOLLE system.



8BL00 wolf gray colour version



cod.
8BL05 "BUNGY S/AUTO"

Same characteristics of 8BL00. Easily adaptable to all Small Auto weapons on the market.



cod.
8BL06 "BUNGY REV."

Same characteristics of 8BL00. Easily adaptable to all small Revolver 2"/2.12"/3" J/K/L Frames.



cod.
8BL01

PISTOL MAGAZINE CASE

Rubber-coated polymer injection molded magazine case. Adjustable through the TUBULAR ELASTIC system. It easily accommodates all double row magazines on the market. The magazine case can mount a MOLLE system on one side or rotating loops on the other. (See page 81 for rotating loops system available)



cod.
8BL02

PISTOL DOUBLE MAGAZINE CASE

Rubber-coated polymer injection molded DOUBLE magazine case. Adjustable through the TUBULAR ELASTIC system. It easily accommodates all double row magazines on the market. The magazine case can mount a MOLLE system on one side or rotating loops on the other. (See page 81 for rotating loops system available)



cod.
8BL13 "BUNGY PANCAKE SLOT"

KIT OF TWO SLOTS FOR MOUNTING ON BUNGEE 8BL00 TYPE HOLSTERS. Belt height adjustment. For wearing close to the body.





T.A.C.S

Tactical Adaptable Carrier System

PENDING PATENT PENDING

DUTY
TACTICAL

CONCEALMENT

SPORT

GLOVES

+

GUIDE

PENDING PATENT PENDING

cod. **8BL03**

RIFLE MAGAZINE CASE
Rubber-coated polymer injection molded magazine case. Adjustable through the TUBULAR ELASTIC system. It easily accommodates all 5,56 magazines on the market. The magazine case can mount a double MOLLE system on both sides and has a system of holes for fastening both a 3-screw loop and for positioning and fastening an 8BL01 type magazine case.



PENDING PATENT PENDING

cod. **8BL14**

HANDCUFF HOLDER IN INJECTION MOLDED RUBBERISED POLYMER
Tubular elastic system allows adjustment, easily adaptable to almost all Medium/Large Handcuff models on the market. It mounts a double MOLLE system and has a system of opening on both for a fastening compatible 3 screw loop.



PENDING PATENT PENDING

cod. **8BL04**

RIFLE DOUBLE MAGAZINE CASE
Rubber-coated polymer injection molded DOUBLE magazine case. Adjustable through the TUBULAR ELASTIC system. It easily accommodates all 5,56 magazines on the market. The magazine case can mount a double MOLLE system on both sides and has a system of holes for fastening both a 3-screw loop and for positioning and fastening an 8BL01 type magazine case.



PENDING PATENT PENDING

cod. **8BLF14**

HANDCUFF HOLDER IN INJECTION MOLDED RUBBERISED POLYMER WITH REMOVABLE AND ADJUSTABLE BUTTON-DOWN FLAP.
Tubular elastic system allows adjustment, easily adaptable to almost all medium/large handcuff models on the market. It mounts a double MOLLE system and has a system of opening on both for a fastening compatible 3 screw loop.



PENDING PATENT PENDING

cod. **8BL07**

MAGAZINE CASE TYPE 308/7,62 IN INJECTION-MOLDED RUBBERISED POLYMER
Tubular elastic system allows adjustment, easily adaptable to almost all 308/7,62 magazine models on the market. It mounts a double MOLLE system and has a system of opening on both sides for a fastening compatible 3 screw loop.



PENDING PATENT PENDING

cod. **8BL08**

DOUBLE MAGAZINE CASE TYPE 308/7,62 IN INJECTION-MOLDED RUBBERISED POLYMER
Tubular elastic system allows adjustment, easily adaptable to almost all 308/7,62 magazine models on the market. It mounts a double MOLLE system and has a system of opening on both sides for a fastening compatible 3 screw loop.



cod. **8BL15**
Open version



TOURNIQUET HOLDER IN INJECTION MOLDED RUBBERISED POLYMER
Tubular elastic system allows adjustment, easily adaptable to almost all Tourniquet models on the market. It mounts a rotating openable loop with "PULL & TURN" system, tilt can be varied by pulling and rotating the case without requiring use of screws/spanners. The adjustable passage allows use on belts of all heights and on the MOLLE system. Front square space to introduce rubberized Cross Patches (see side).



cod. **8BLF15**
Adjustable flap cover with snap closure version



PENDING PATENT PENDING

- cod. **PTC01**
- cod. **PTC02**
- cod. **PTC03**
- cod. **PTC04**
- cod. **PTC05**





TACTICAL > T.A.C.S. LINE



cod. **8BL20** "INSIDE BUNGY L/AUTO"

INSIDE HOLSTER IN INJECTION MOLDED RUBBERISED POLYMER
Tubular elastic system allows adjustment, easily adaptable to all Large Auto and Large Auto Compact weapons on the market. It mounts a double-fastener inside clip close to the side. Tilt adjustment and two possible heights.

AVAILABLE FOR
L/Auto – L/Auto Compact



cod. **8BL21** "INSIDE BUNGY S/AUTO"

INSIDE HOLSTER IN INJECTION MOLDED RUBBERISED POLYMER
Tubular elastic system allows adjustment, easily adaptable to all Small Auto weapons on the market. It mounts a double-fastener inside clip close to the side. Tilt adjustment and two possible heights.

AVAILABLE FOR
Small Auto



TACTICAL > T.A.C.S. LINE



cod. **8BL09**
Non-slip rubber safety-catch for all T.A.C.S. Line magazine cases



cod. **8K87**

Multipurpose long loop can be opened and is compatible with both duty belts and Molle System. Adjustable tilt and height through a series of holes. Adjustment bar for internal height passage. Closing system with lock



cod. **8K82**

Multipurpose loop which can be opened and adjusted in height and cant through a series of slots. Belt adjustable height, lock with safety system.



cod. **8K81**

Compact rotating Belt loop, double slot 5,5 cm

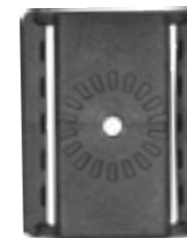

cod. **8K84**

Rotating Belt loop, adjustable belt passage.



cod. **8K50**

ROTATING SYSTEM CLIP
System for reducing belt passage.



cod. **8K83**

Rotating Compact Molle Kit Allow the angle adjustment by screw.



cod. **8K75**

MOLLE Sticks 75 mm



cod. **8K125**

MOLLE Sticks 125 mm



DUTY
TACTICAL
CONCEALMENT
SPORT
GLOVES
+
GUIDE



TACTICAL > POLYMER THIGH HOLSTERS



series **DCXT8** "CAMA X COMPACT THIGH KIT"

PROFESSIONAL THIGH HOLSTER IN INJECTION MOLDED POLYMER
Double safety system: one locks the upper part of the weapon and the second one acts on the trigger guard and automatically activates when the weapon is inserted in the holster.
Both systems can be released either individually or simultaneously using a lever on the inside of the holster, operated with the thumb in a "BACK & GO" movement.
Retention screw for adjusting the friction of the holster on the weapon.
Thigh system in polymer with modular support
Height and tilt can be adjusted using the screws.
Single thigh strap with rotating buckle for easy movement.
Rotating loop can be removed for attachment to belt directly on thigh extension and use in High-Thigh position.
Elastic thigh strap with non-slip bands.
Support with toothed wheels for attachment of compatible rotating system accessories.
It can be mounted on all Vega Holster loops and kits.

AVAILABLE FOR
-Glock 17/18/19/22/23/31/32/45/47 -Sig Sauer P320 Full Size/Compact/M17/M18



series **CCXT8** "CAMA X OPEN COMPACT THIGH KIT"

PROFESSIONAL THIGH HOLSTER IN INJECTION MOLDED POLYMER
Lower safety system that acts on the trigger guard automatically activates when the weapon is inserted in the holster.
It can be released by means of a thumb-operated lever on the inside of the holster in a "BACK & GO" movement.
Retention screw for adjusting the friction of the holster on the weapon.
Thigh system in polymer with modular support.
Height and tilt can be adjusted using the screws.
Single thigh strap with rotating buckle for easy movement.
Rotating loop can be removed for attachment to belt directly on thigh extension and use in high-thigh position.
Elastic thigh strap with non-slip bands.
Support with toothed wheels for attachment of compatible rotating system accessories.
It can be mounted on all Vega Holster loops and kits.

AVAILABLE FOR
-Glock 17/18/19/22/23/31/32/45/47 -Sig Sauer P320 Full Size/Compact/M17/M18



TACTICAL > POLYMER THIGH HOLSTERS



series **DCHLX8** "CAMA X LARGE THIGH KIT"

PROFESSIONAL THIGH HOLSTER IN INJECTION MOLDED POLYMER
Double safety system: one locks the upper part of the weapon and the second one acts on the trigger guard.
Both systems can be released individually or simultaneously by means of a lever on the inside of the holster which can be operated with the thumb in a "BACK & GO" movement.
Retention screw for adjusting the friction of the holster on the weapon.
Thigh system in polymer with modular support.
Double belt attachment with rotating buckle for easy movement.
Double thigh strap with non-slip bands.
Support with slots for anchorage of MOLLE type accessories and toothed wheels for attachment of compatible rotating system accessories.
It can be mounted on all Vega Holster loops and kits.

AVAILABLE FOR
-Glock 17/18/19/22/23/31/32/45/47 -Sig Sauer P320 Full Size/Compact/M17/M18



series **CCHLX8** "CAMA X OPEN LARGE THIGH KIT"

PROFESSIONAL THIGH HOLSTER IN INJECTION MOLDED POLYMER
Safety system that acts on the trigger guard and automatically activates when the weapon is inserted in the holster.
It can be released by means of a thumb-operated lever on the inside of the holster in a "BACK & GO" movement.
Retention screw for adjusting the friction of the holster on the weapon.
Thigh system in polymer with modular support.
Double belt attachment with rotating buckle for easy movement.
Double thigh strap with non-slip bands.
Support with slots for anchorage of MOLLE type accessories and toothed wheels for attachment of compatible rotating system accessories.
It can be mounted on all Vega Holster loops and kits.

AVAILABLE FOR
-Glock 17/18/19/22/23/31/32/45/47 -Sig Sauer P320 Full Size/Compact/M17/M18



COMPATIBLE ROTATING SYSTEM ACCESSORIES

cod. **8V31** with lock.
cod. **8V33** without lock.
Retractable key and multi tools holder.



cod. **8MH00**
Magazine holder, adjustable flap, inside spring.



cod. **8MH01**
Open P/double row magazine case with double retention screws.



cod. **8VP62**
Universal 21" Baton Holder, retention springs.



cod. **8VP63**
Universal flash light/baton 16" holder. Retention springs.



cod. **8K36**
Picantilly rail.





TACTICAL > POLYMER THIGH HOLSTERS



DCHT8 full set sample

Front shield IN

Front shield Out



DOUBLE OPTIONS INCLUDED



Partial cover

Total cover

series **DCHT8** "CAMA COMPACT THIGH KIT"

PROFESSIONAL POLYMER INJECTION MOLDED HOLSTER
Retention level III. Retention screws and clip with double friction points. Thumb release of the upper Safety lock. Index finger release of the lower Safety lock. Possibility of closing the bottom opening. Possibility of fully covered index finger safety lever. Compact thigh kit with rotating buckle for easy movements. It can be mounted on all Vega Holster loops and Kits.

AVAILABLE FOR
-Glock 17/18/22/19/23/31/32/45/47. -Beretta PX4/APX, 92/98/A1 -H&K P30/P30L -H&K VP9/SFP9



COMPATIBLE ROTATING SYSTEM ACCESSORIES

cod. **8V31** with lock.
cod. **8V33** without lock.
Retractable key and multy tools holder.



cod. **8MH00**
Magazine holder, adjustable flap, inside spring.



cod. **8MH01**
Open P/double row magazine case with double retention screws.



series **DCHL8** "CAMA LARGE THIGH KIT"

PROFESSIONAL POLYMER INJECTION MOLDED HOLSTER
Retention level III. Retention screws and clip with double friction points. Thumb release of the upper Safety lock. Index finger release of the lower Safety lock. Possibility of closing the bottom opening. Possibility of fully covered index finger safety lever. FULL thigh kit with double Belt attach. lace including rotating buckle, double thigh retention laces with No slip stripes and adjustments Buckles closure. It can be mounted on all Vega Holster loops and Kits.

AVAILABLE FOR
-Glock 17/18/22/19/23/31/32/45/47. -Beretta PX4/APX, 92/98/A1 -H&K P30/P30L -H&K VP9/SFP9



series **DCHL08** "CAMA OPEN LARGE THIGH KIT"

PROFESSIONAL POLYMER INJECTION MOLDED HOLSTER
Retention level II. Retention screws and clip with double friction system. Bottom lock releases with index finger. Possibility of closing bottom opening. Possibility of inserting complete front lock cover. Possibility of inserting high frontal protection. Double Belt attachment thigh kit with rotating buckle for ease of movements, double strap for anchoring onto thigh. Possibility of mounting on all Vega Holster loops and Kits. Possibility of inserting R.S.A. ROTATING SYSTEM ACCESSORIES

AVAILABLE FOR
-Glock 17/18/19/22/23/31/32/45/47 -Beretta APX, 92/98/A1 -H&K P30/P30L -H&K VP9/SFP9



cod. **8VP62**
Universal 21" Baton Holder, retention springs.



cod. **8VP63**
Universal flash light/baton 16" holder. Retention springs.



cod. **8K36**
Picantilly rail.





TACTICAL > POLYMER THIGH HOLSTERS



series **DCAL8** "CAMA ALL ONE LARGE THIGH KIT"

PROFESSIONAL POLYMER INJECTION MOLDED HOLSTER Retention level III. Retention screws and clip with double friction system. Thumb release of upper and lower locks, both with one single lever/button situated inside the holster. Possibility of closing bottom opening. Double belt attachment thigh kit with rotating buckle for ease of movements, double strap for anchoring onto thigh. International patent. Possibility of mounting on all Vega Holster loops and kits. Possibility of inserting R.S.A. ROTATING SYSTEM ACCESSORIES

AVAILABLE FOR Beretta 92/98 -Glock 17/18/19/22/23/31/32/45/47



series **DCAT8** "CAMA ALL ONE COMPACT THIGH KIT"

PROFESSIONAL POLYMER INJECTION MOLDED HOLSTER Retention level III. Retention screws and clip with double friction system. Thumb release of upper and lower locks, both with one single lever/button situated inside the holster. Possibility of closing bottom opening. Single belt attachment thigh kit with rotating buckle for ease of movements, elastic strap with anti-slide grooves for anchoring onto thigh. International patent. Possibility of mounting on all Vega Holster loops and kits. Possibility of inserting R.S.A. ROTATING SYSTEM ACCESSORIES.

AVAILABLE FOR Beretta 92/98 -Glock 17/18/19/22/23/31/32/45/47



TACTICAL > POLYMER THIGH HOLSTERS



series **SHWN8** Single belt attach



series **SHWL8** "SHOCKWAVE LARGE THIGH KIT"

HOLSTER IN INJECTION MOLDED POLYMER WITH DOUBLE SAFETY SYSTEM 1) Acts on the top part of the weapon. By pressing the lever, the swivel part opens leaving the upper passage free. 2) Acts on the trigger guard of the weapon. Automatically activated when the weapon is inserted in the holster and deactivated by keeping the middle finger pressed under the grip of the weapon. The holster has a screw for adjusting the retention of the weapon in the holster. The holster is fitted to an injection molded thigh kit The thigh support has 4 slits for inserting molle type accessories, 2 molded hubs for inserting magazine cases type 8MH00 and 6 series of holes for the insertion of accessories using screws. The thigh system has two elastic straps with non-slip bands in silicone for anchorage to the thigh and 2 adjustable extensions with rotating buckles for attachment to the belt. (also available in the version with single attachment to the thigh art. SHWV8).

AVAILABLE FOR Beretta 92/98, -Taurus PT92 -Sig Sauer 2022 -H&K USP Stand. & Compact -Glock 17/18/19/22/23/31/32/45/47



series **SHWT8** "SHOCKWAVE COMPACT THIGH KIT"

THIGH HOLSTER IN INJECTION MOLDING POLYMER WITH DOUBLE SAFETY MECHANISM 1) Acts on the top part of the weapon. By pressing the lever, the swivel part opens leaving the upper passage free. 2) Acts on the trigger guard of the weapon. Automatically activated when the weapon is inserted in the holster and deactivated by keeping the middle finger pressed under the grip of the weapon. The holster has a screw for adjusting the retention of the weapon in the holster. Compact thigh platform in injection molded polymer, single thigh strap with no-slip rails. Adjustable Belt strap with a special swivel buckle for adapting to your body movements. Dual toothed wheel Y on the sides for attaching ROTATING SYSTEM ACCESSORIES compatible.

AVAILABLE FOR Beretta 92/98 -Glock 17/18/19/22/23/31/32/37/38/45/47 -H&K USP Compact. and standard -Sig Sauer 2022



COMPATIBLE ROTATING SYSTEM ACCESSORIES

cod. **8V31** with lock. cod. **8V33** without lock. Retractable key and multy tools holder.



cod. **8MH00** Magazine holder, adjustable flap, inside spring.



cod. **8MH01** Open P/double row magazine case with double retention screws.



cod. **8VP62** Universal 21" baton holder, retention springs.



cod. **8VP63** Universal flash light/baton 16" holder. Retention springs.



cod. **8K36** Picatinny rail.





series **DAAT8** "ACE COMPACT THIGH KIT"

PROFESSIONAL THIGH HOLSTER IN INJECTION MOLDED POLYMER "PUSH & FRONT" upper safety system uses a swivel strap acting on the upper part of the weapon, releasable by means of a downward and then forward thumb movement. Front Stop" safety system, acting on the ejection hole, releasable by means of a lever located on the inside of the holster, thumb-operated in a natural rear movement. Retention screw for adjusting the friction of the holster on the weapon. Thigh system in polymer with modular support. Height and tilt can be adjusted using the screws. Single belt attachment with rotating buckle for easy movement. Rotating loop can be removed for attachment to belt directly on thigh extension and use in High-Thigh position. Elastic thigh strap with non-slip bands. Support with toothed wheels of compatible rotating system accessories. It can be mounted on all Vega Holster loops and kits.

AVAILABLE FOR -Glock 17/18/19/22/23/31/32/45/47 -H&K USP Compact -Sig Sauer P320 Full Size/Compact/M17/M18

SAFETY GRADE 3 AFS not for all models [icons]



series **DAAL8** "ACE LARGE THIGH KIT"

PROFESSIONAL THIGH HOLSTER IN INJECTION MOLDED POLYMER "PUSH & FRONT" upper safety system uses a swivel strap acting on the upper part of the weapon, releasable by means of a downward and then forward thumb movement. Front Stop" safety system, acting on the ejection hole, releasable by means of a lever located on the inside of the holster, thumb-operated in a natural rear movement. Height and tilt can be adjusted using the screws. Retention screw for adjusting the friction of the holster on the weapon. Thigh system in polymer with modular support. Double belt attachment with rotating buckle for easy movement. Double thigh strap with non-slip bands. Support with slots for anchorage of MOLLE type accessories and toothed wheels of compatible rotating system accessories. It can be mounted on all Vega Holster loops and kits.

AVAILABLE FOR -Glock 17/18/19/22/23/31/32/45/47 -H&K USP Compact -Sig Sauer P320 Full Size/Compact/M17/M18

SAFETY GRADE 3 AFS not for all models [icons]

series **VKN8** "NATION"

HOLSTER WITH THIGH PLATFORM Double belt loops with turn buckle for a better movement, double no slip elastic leg strap. Polymer holster with inside lining for a gun protection, turn safety lace. Injection molding platform with holes molle compatible and multi attach. points for screws accessories.

AVAILABLE FOR -Beretta APX, 84/92/96/98/PX4, 90 two, 98 a1 -Colt 1911, e simili -Glock 17/19/20/21/22/23/31/32/37/38/45/47 -H&K VP9/SFP9, P30, USP Standard, USP Compact -Sig Sauer P320, 2022, P226Rail, P250 -Tanfoglio Police, Pro -Walther P99 last edition, PPQ, P99Q -FN Five Seven N -CZ SP01 -Caracal F and C -Revolver S&W 3" and 4" K & L Frame -S&W M&P M2.0 5"

SAFETY GRADE 2 [icons]



series **VKC8** "CAVALLERY"

COMPACT THIGH HOLSTER With turn buckle for a better movement, single no slip elastic leg strap. Polymer holster with inside lining for a gun protection, turn safety lace.

AVAILABLE FOR -Beretta APX, 84/92/96/98/PX4, 90 two, 98 a1 -Colt 1911, e simili -Glock 17/19/20/21/22/23/31/32/37/38/45/47 -H&K VP9/SFP9, P30, USP Standard, USP Compact -Sig Sauer P320, 2022, P226Rail, P250 -Tanfoglio Police, Pro -Walther P99 last edition, PPQ, P99Q -FN Five Seven N -CZ SP01 -Caracal F and C -Revolver S&W 3" and 4" K & L Frame -S&W M&P M2.0 5"

SAFETY GRADE 2 [icons]



series **VKV8** "VETERAN"

HOLSTER WITH THIGH PLATFORM Adjustable belt loop, double no slip elastic leg strap. Polymer holster with inside lining for a gun protection, turn safety lace. Thermo molded platform with holes molle compatible.

AVAILABLE FOR -Beretta APX, 84/92/96/98/PX4, 90 two, 98 a1 -Colt 1911, e simili -Glock 17/19/20/21/22/23/31/32/37/38/45/47 -H&K VP9/SFP9, P30, USP Standard, USP Compact -Sig Sauer P320, 2022, P226Rail, P250 -Tanfoglio Police, Pro -Walther P99 last edition, PPQ, P99Q -FN Five Seven N -CZ SP01 -Caracal F and C -Revolver S&W 3" and 4" K & L Frame -S&W M&P M2.0 5"

SAFETY GRADE 2 [icons]





series
VKLZ8 "ZOOM THIGH KIT"

THERMO MOLDING POLYMER HOLSTER FOR PISTOL WITH FLASHLIGHT OR/AND LASER

Easy action safety system on the top. Retention screw on the lower part of the pistol. Two adjustable parts in rubber and nylon at the point of the trigger guard according to the model of flashlight or/and laser mounted on the pistol. Polymer thigh platform with 4 holes to mount Molle System accessories. 2 points to insert the magazine cases 8MH00 and 6 holes to insert accessories with screws. Dual no-slip leg straps and dual adjustable thigh extension with swivel buckles. (Available also with belt support VKZ8).

AVAILABLE FOR
-Glock 17/18/19/22/23/31/32/45/47 e simili montate con torcia e/o laser -Sig Sauer P220/226, -Springfield XDM all With Laser or Light



series
VKLW8 "WARRIOR THIGH KIT"

LEVEL II SECURITY

Special thermo-molded polymer holster, suitable for Duty and tactical operators. Inner lining to provide greater weapon safety and sound-free handling. Upper safety system with rotating lace. It can be used with or without internal shield (both components are included). Retention screws on barrel. The holster is mounted on an injection molded thigh platform. The thigh platform is provided with 4 slots for inserting molle accessories, two toothed wheels for attaching ROTATING SYSTEM ACCESSORIES compatible, and a series of 6 slots for inserting accessories by screws. The thigh system present two straps with no-slip bands for thigh and double belt loops attach. with adjustable extensions and swivel buckles(single thigh attachment version also available kit 8K16). "Compatible with all Vega Holster Belt loops and platforms kit"

AVAILABLE FOR
-Glock 17/19/22/23/31/32/37/38/45/47 with Stremlight LT1 and LT2 -FN Herstal FNS9 with Surfire X300



series
VKLQR8 "QUANTUM R THIGH KIT"

PROFESSIONAL HOLSTER IN INJECTION MOLDED POLYMER SUITABLE FOR WEAPONS WITH TACTICAL TORCHES AND/OR LASERS AND FRONT RDO MOUNTING.

ASPF" upper safety system adjusted by a swivel strap acting on the upper part of the weapon, releasable by means of a downward and then forward movement of the thumb. "Ace Front Stop" safety system, acting on the ejection hole, releasable by means of a lever located on the inside of the holster, thumb-operated in a natural rear movement. Retention screw for adjusting the friction of the holster on the weapon. Torch/Laser passage adjustment screw. Front part with removable cover to protect RDO. Loop for belt with double slots and adjustment of belt passage from 5 cm to 6 cm, grip position on the belt line. It can be mounted on all Vega Holster loops and kits. Thigh system in polymer with modular support. Double belt attachment with rotating buckle for easy movement. Double thigh strap with non-slip bands. Support with slots for anchorage of MOLLE type accessories and toothed wheels for attaching compatible accessories. It can be mounted on all Vega Holster loops and kits.

AVAILABLE FOR
-Glock 17/18/19/22/23/31/32/45/47 -Sig Sauer P320 Full Size/Compact/M17/M18 mounted on Torce Surfire X300, Streamlight TLR1/2 and similar



series
VKLQ8 "QUANTUM THIGH KIT"

PROFESSIONAL THERMO MOLDED POLYMER THIGH HOLSTER SUITABLE FOR WEAPONS WITH TACTICAL TORCHES AND/OR LASERS.

ASPF" upper safety system adjustable using a swivel strap acting on the upper part of the weapon, releasable by means of a downward and then forward thumb movement. "Ace Front Stop" safety system, acting on the ejection hole, releasable by means of a lever located on the inside of the holster, thumb-operated in a natural rear movement. Retention screw for adjusting the friction of the holster on the weapon. Torch/Laser passage adjustment screw. Thigh system in polymer with modular support. Double belt attachment with rotating buckle for easy movement. Double thigh strap with non-slip bands. Support with slots for anchorage of MOLLE type accessories and toothed wheels for attaching compatible accessories. It can be mounted on all Vega Holster loops and kits.

AVAILABLE FOR
-Glock 17/18/19/22/23/31/32/45/47 - Sig Sauer P320 Full Size/Compact/M17/M18 mounted on Torce Surfire X300, Streamlight TLR1/2 and similar





TACTICAL > NYLON HOLSTERS

cod. PA270

TACTICAL NYLON THIGH HOLSTER

Tactical thigh holster in nylon, quick release with safety lace, adjustable and removable. Third safety tubular/elastic system. Adjustable flap magazine case. Two different positions: on the leg adjustable high or direct on the belt without thigh support and bands. Thigh support with 3 points safety buckle. No slip bands.

AVAILABLE FOR
L/Auto -> PA270 - L/Auto Compact -> PA271



cod. PA280

ADJUSTABLE TACTICAL THIGH HOLSTER FOR PISTOL WITH FLASHLIGHT OR LASER

Quick release with safety lace, adjustable and removable third safety tubular/elastic system. Adjustable flap magazine case. Two different positions: on the leg adjustable high or direct on the belt without thigh support and bands. Thigh support with 3 points safety buckle. No slip bands.

AVAILABLE FOR
L/Auto - L/Auto Compact



TACTICAL > NYLON HOLSTERS

series PA2

TACTICAL NYLON THIGH HOLSTER

Tactical nylon thigh holster. Quick release with second safety lace, padded strap on the holster for greater comfort and better stability. Possibility to insert magazine case.

AVAILABLE FOR
L/Auto, L/Auto Compact, M/Auto



series FPA2

TACTICAL MOLDED NYLON THIGH HOLSTER

Tactical molded nylon thigh holster, adjustable quick release with safety system "Vega Stop snap", padded strap on the holster for greater comfort and better stability. Possibility to insert magazine case.

AVAILABLE FOR
L/Auto - L/Auto Compact



series LTL2

MULTIFUNCTION NYLON HOLSTER

Special adjustability of the lower part makes this holster suitable for weapons with or without tactical light or laser. Adjustable Quick release on the top and on the trigger guard. Possibility of use on a belt through ribbon belt loop. Compatible with thigh kit (included), adjustable belt and thigh attachment laces.

AVAILABLE FOR
L/Auto - L/Auto Compact



Use with Light/Laser mounted

Use without Light/Laser mounted.





TACTICAL > NYLON HOLSTERS



series
MM2+2KM02



series
MM2

NYLON MODULAR MILITARY HOLSTER.
Ambidextrous. Adjustment thumb snap lace with safety closure. Pistol grip elastic retention. Magazine case with adjustable flap. Belt and all Molle Platforms compatible. Compatible with thigh kit item 2KM02

AVAILABLE FOR
L/Auto -> MM200 - L/Auto Compact MM203



cod.
2KM02

MODULAR THIGH PLATFORM FOR MM2 HOLSTER
Adjustable Attach. Belt Lace with Safety Buckle. Thigh Laces with double No-Slip rows.



TACTICAL > NYLON HOLSTERS

series
MB220L

NYLON MILITARY HOLSTER REINFORCED WITH POLYMER INSERT
Same characteristics of MB2 holster but with the complete cover of the pistol grip.

AVAILABLE FOR
L/Auto



series
MB2

NYLON MILITARY HOLSTER REINFORCED WITH POLYMER INSERT

Nylon military ambidextrous holster reinforced with polymer insert, quick release flap, amovible steel belt loop, belt loops for 4 cm belt use, barrel cleaning stick inserted in front side, possibility to insert the quick release (included). Possible optional: thigh kit item 2K13 and shoulder kit 2K11.

AVAILABLE FOR
L/Auto - L/Auto Compact



series
M2

NYLON FLAP HOLSTER
Flap velcro closure, polymer belt loop with double snaps. Possibility to insert the safety lace. Optional Kit thigh system 2K10.

AVAILABLE FOR
L/Auto - L/Auto Compact - M/Auto - Rev. 4", 6", Desert Eagle



cod.
2K13

THIGH KIT FOR MB2/MB2L IN NYLON AND POLYMER
thigh kit for MB2/MB220L. No slip webbing, adjustable high, possibility to insert the magazine case.



cod.
2ET02

MIRIAMESH TACTICAL VEST.

Adjustable on shoulders and sides. Six adjustable M16- AR 70/90 magazine case, double utility pocket, 6 holes pocket for cal.12. Hydration system compatible. Back bands system. Duty drag handle and belt laces.



cod.
2ET03

MIRIAMESH TACTICAL VEST

MiriaMeshTactical Vest. Adjustable on shoulders and sides. Triple adjustable AR 70/90-M16 magazine case, utility pocket, 6 holes pocket for cal.12, pistol L/Auto Holster with adjustable safety lace and adjustable magazine case. 3 adjustable utility pockets. Hydration system compatible. Velcro band for inscriptions insert (not included) on the back, Alice webbing system. Duty drag handle and belt laces.



cod.
2ET06

MESH AND NYLON TACTICAL VEST WITH MODULAR LACES SYSTEM

Compatible with Molle System, three magazine cases and an utility pocket on the chest. No slip rubber padded reinforce on the shoulders, adjustable on the shoulders and on the sides, double internal pockets with zip closure. Safety drag handle.



cod.
2ET11

COMPACT PLATE CARRIER WITH FRONT AND REAR MOLLE SYSTEM

Velcro for front and rear Patch. Side closing system with STRAPS and PLASTIC BUCKLE, adjustable sides and shoulders. Pockets for internal plates with Velcro closure. Padded for greater comfort.



cod.
2ET08

CHEST NYLON SYSTEM

Four cases for M4/AR 70-90 magazine, modular system for attach of others accessories, mesh pockets on the back, adjustable shoulder ribbon.



cod.
2ET10

CHEST SYSTEM WITH ADJUSTABLE SHOULDER STRAPS.

Front platform for carrying molle/pal accessories, pockets in mid position with elastic safety lace for Ak47/Ar70/M4 magazines, padded internal pocket for greater comfort.



cod.
PA290 "MP7-V/HOLDER"

DOUBLE SAFETY LACES.

Adjustable belt lace with triple safety buckle. Double thigh harness with no slip rubber parts. Adjustable fit by velcro system. Disponibile/Available: Destro e sinistro/Right and Left. Suggested for: H&K MP7



cod.
2V79 "H&K MP7"

cod.
2V70 "H&K MP5"

SHOULDER HARNESS FOR MP5 WITH TRIPLE MAGAZINE HOLDER
Shoulder harness for MP5 with triple magazine holder, it can be detached for use on the belt without shoulder system.





TACTICAL > MODULAR SYSTEM



cod. **2SM00**

TACTICAL VEST FRONT IN NYLON BACK IN MIRIAMESH
Adjustable on shoulders and sides. Hydration system compatible.
Double inside pockets



cod. **2SM23**

29x23x6 cm



cod. **2SM24**

20x18x6 cm



UTILITY BAGS
Modular system or belt use.
Adjustable nylon buckles closure.



TACTICAL > MODULAR SYSTEMS



cod. **8K75**

MOLLE STICKS 7,5 CM



cod. **8K125**

MOLLE STICKS 12,5 CM



cod. **2SM26**

DOUBLE USE HANDCUFF CASE
modular system or belt. Velcro closure.



cod. **2SM30**
15x15x9 cm

MULTI-PURPOSE
Double use modular system or belt. Zip closure.



cod. **2SM19**

FLASHBANG CASE
Modular system or belt use. Adjustable velcro lids.



cod. **2SM22**

UNIVERSAL FLASHLIGHT CASE
Modular system or belt use. Adjustable velcro lids. Adjustable velcro bands system.



cod. **2SM20**

RADIO CASE
Modular system or belt use. Adjustable elastic lace closure.



cod. **2SM21**

UNIVERSAL MOBILE PHONE CASE
Modular system or belt use. Adjustable nylon buckle closure. Adjustable velcro bands system.



2SM27

DOUBLE MAGAZINE CASE FOR 5.56
double use modular system or belt. Velcro closure..



2SM14

TRIPLE M16-AR70/90 MAGAZINE CASE
Modular system or belt use. Adjustable nylon buckles closure. Elastic retention.



cod. **2SM28**

DOUBLE MAGAZINE CASE FOR MP5
Double use modular system or belt. Velcro closure.



cod. **2SM16**

TRIPLE H&K MP5 MAGAZINE CASE
Modular system or belt use. Adjustable velcro lids. Elastic retention.



cod. **2SM15**

TRIPLE M16-AR70/90 MAGAZINE CASE
Modular system or belt use. Adjustable nylon buckle closure. Utility pocket. Elastic separators.



cod. **2SM12**

DOUBLE MAGAZINES CASE
Modular system or belt use. Adjustable velcro lids.



cod. **2SM11**

MAGAZINE CASE
Modular system or belt use. Adjustable velcro lids.



cod. **2SM13**

M16-AR70/90 MAGAZINE CASE
Modular system or belt use. Adjustable velcro lids. Elastic retention.



cod. **2SM29**

MAGAZINE CASE FOR TWO 5.56 MAGAZINE AS AR70/90, M16
Nylon. Adjustable flap closure and Molle compatible belt loop system.



cod. **2SM18**

GRANADE CASE
Modular system or belt use. Velcro and snap closure.



cod. **2SM17**

SIX CAL. 12 SHOTGUN CASE
Modular system or belt use. Velcro closure. Elastic loops.





series
2K91

DOUBLE MAGAZINE AR70/90/M4
Tactical thigh pouch made in cordura, padded on the back, you can use without the leg system direct on the belt, no-slip leg straps. Cover flaps adjustable and removable.



cod.
2K93

FOUR MAGAZINE AR70/90
M16 tactical thigh pouch made in cordura. Padded on the back. You can use it without the leg system direct on the belt with double belt loops. No-slip leg straps, cover flaps adjustable and removable. Elastic inside dividing.



cod.
2K92

DOUBLE MAGAZINE H&K G3
Tactical thigh pouch made in cordura. Padded on the back, you can use without the leg system direct on the belt. No-slip leg straps. Cover flaps adjustable and removable.



series
2K90

TRIPLE MAGAZINE H&K MP5 TACTICAL THIGH POUCH
Tactical thigh pouch made in nylon. padded on the back. You can use without the leg system direct on the belt. No-slip leg straps, cover flaps adjustable and removable.



cod.
2K94

TRIPLE MAGAZINE PISTOL TACTICAL THIGH POUCH
Triple magazine pistol tactical thigh pouch made in cordura. Padded on the back, you can use without the leg system direct on the belt. No-slip leg strap. Cover flaps adjustable and removable.



cod.
2K80

GAS MASK POUCH
You can use on the thigh with adjustable and removable Thigh Sytem, on the belt with webbing belt loops or on shoulder with shoulder strap. Double closure with velcro and nylon buckles. Two utility pouchs on the sides.



cod.
2WM02

ID-BADGE HANGER
It has a lid secured with hook & loop. Multi pockets for ID, business cards, etc. Windows sizes: 11,5 x 9,5 cm.



cod.
2WM00

MULTIFUNCTION NYLON HOLDER
With 3 pockets.



cod.
2V25

KEY HOLDER
With metal hooks.



cod.
2V22

PISTOL SAFETY LACE
With molten terminal.



cod.
2G12

MEDICAL OR MULTI-USES POCKET
Inside with elastic loops and velcro pockets. External pockets with velcro closure. Molle Belt Loop system.

Dimensions: H 15 x L 16 x P 5 cm



cod.
2G10
Medium size

cod.
2G11
Large size

ALL USES FOLDABLE BELT POUCH
With velcro closure and adjustable elastic ring.



cod.
2G13

WRITE PAD POCKET
External general Pockets with Velcro closure. Nylon Belt loop.

Dimensions: H 15 x L 2,5 x P 2 cm





cod.
2ZM16

TACTICAL BACKPACK WARRIOR

Padded back panel with movable inside aluminum bar lateral restraining straps and upper straps for added load stability. Padded and anatomic waist belt and adjustable shoulder straps. Large compartment with total opening with inside straps to anchorage equipment, medium compartment with zip and buckle closure. Side and front Modular System laces. Built-in jump harness with heavy duty parachute webbings drag/ carry handle. Hydration system compatible.

Measures: 24 x 40 x h58 cm.



cod.
2ZM17

WARRIOR COMPACT

Nylon backpack, internal padding, back reinforce, aluminum rod. Concealed rear pocket. Containment straps on the sides and upper part. Padded shoulder and lower back straps. Pocket with great holding capacity. Pocket with medium holding capacity. Modular system on sides and on front flap. It can be used with hydration system. Lower attachment system for use during airdrop. Reinforced handle. Side pockets and front openable large FLAP for helmet/equipment carry.

Measures: cm 22 x 30 x h 50



cod.
2ZM20

TACTICAL BACKPACK IN POLYAMIDE WITH PADDED BACK PANEL

Lateral containment belts and upper straps for balancing load. Padded shoulder straps and waist belt, large compartment with top opening, medium size compartment, front opening for inserting and anchoring weapon or helmet. Outer tapes system for attaching pockets and Molle type accessories. Inner arrangement for hydration system (not included).

Measures: H 45 x L 33 x P 20 cm. Capacity 40 lt.



cod.
2ZM19

SINGLE SHOULDER RUCKSACK IN POLYAMIDE

Padded shoulder strap attaches to right or left side. Large inner compartment opens fully at the top and lower side opening, double multipurpose pocket on front. Outer tapes system for attaching pockets and Molle compatible accessories. The main compartments are padded for transporting even fragile materials.

Measures: H 53 x L 21 x P 18 cm



cod.
HS04

HYDRATION SYSTEM OF 3 LT. WITH ANTIMICROBIAL

Small backpack with handles and rings for attaching bags. Hydration system of 3 lt. with antimicrobial protection MICROBAN. Outer shell in neoprene tube.



cod.
HS03

INSIDE HYDRATION SYSTEM OF 3 LT

Small backpack with slim recommended for inside of a backpack or attached to vest with shoulder straps. Handles and rings for attaching bags. Hydration system of 3 lt. with antimicrobial protection MICROBAN. Outershell in neoprene tube.



cod.
HS05

HYDRATION SYSTEM 3 LT

Small backpack with adjustable straps, upper carrying handle, hydrating system with upper closure concealed under a flap, antimicrobe MICROBIAN system. Outer shell in neoprene tube, valve with lock system.





cod. **2B37** "CARGO BAG EXPLORER"

SINGLE SHOULDER TACTICAL BAG CAN BE USED AS RUCKSACK OR ON BELT
Two outer zip pockets. Central pocket with inside adjustable universal holster, quick release rip opening with outer string, for left and right handed users. Padded shoulder strap for use as one strap, it can be worn on the back and a rotating position front wards in case of danger or needing a fast weapon extraction. Loop for belt wearing with thigh anchor strap. Upper carry handle for fast anti-panic opening. Molle System for attaching various accessories. Compatible with 2VS Velcro system accessories.



Measures: H 22 x L 18 x D 8 cm



cod. **2B35** "CARGO BAG CITY"

MULTI-POCKET BAG IN NYLON
Double uses belt for to use as shoulder strap or as standard belt on the hip. Thigh lace for a better stability during sport activity. Large compartment with fast open system compatible with Velcro System, it is possible to attach inside an holsters and/or various accessories. Other pockets to carry several other objects.



Measure: H 24 x L 20 x D 8 cm.



cod. **2B31** "CARGO BAG URBAN"

MULTI-POCKET BAG IN NYLON
(Urban Cargo Bag) Multi-pocket bag in Cordura. Shoulder strap with possibility to anchor it by a belt. Transparent net on the back. Large compatible modular pocket with "Sistema Velcrabile 2VS" for fast complete opening with the possibility to secure it with two sliding clips. Inner and external pockets to carry several other objects.



Measures: L 23 x W 14 x D 6 cm.



cod. **2B32** "CARGO BAG EXPEDITION"

MULTI-POCKET BAG IN NYLON
(Urban Cargo Bag) Multi-pocket bag in Nylon. Shoulder strap with possibility to anchor it by a belt. Transparent net on the back. Large compatible modular pocket with "Velcro System" for fast complete opening with the possibility to secure it with two sliding clips. Inner and external pockets to carry several other objects.



Measures: L 22 x W 18 x D 6 cm



COMPATIBLE VELCRO MODULAR SYSTEM ACCESSORIES



cod. **2VS09**
ADJUSTABLE PISTOL HOLSTER.
Velcro on the back.



cod. **2VS11**
NYLON DOUBLE MAGAZINE CASE
With all velcro back, adjustable velcro closure. All the velcro female surface compatible.



cod. **2VS12**
NYLON MAGAZINE CASES
with all velcro back, adjustable velcro closure. All the velcro female surface compatible.



cod. **2VS25**
NYLON HANDCUFFS CASE
with all velcro back, adjustable velcro closure. All the velcro female surface compatible.

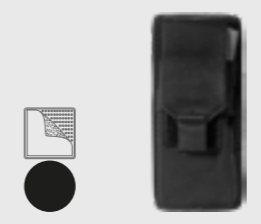

cod. **2VS13**
NYLON M4/AR 70-90 MAGAZINE CASE
with all velcro back, adjustable velcro closure. All the velcro female surface compatible.



cod. **2VS20**
NYLON RADIO CASE
with all velcro back, adjustable velcro closure. All the velcro female surface compatible.



cod. **2VS26**
NYLON BATON CASE
with all velcro back, adjustable velcro closure. All the velcro female surface compatible.



cod. **2B33** "CARGO BAG TRAVEL"

MULTI-POCKET BAG IN NYLON

(Travel Cargo Bag) Multi-pocket bag in Cordura. Inner padded compartment for the protection of electronic instruments such as laptops, with an adaptable and removable multi-pocketed panel, a back pocket for documents with fastener and secret front pocket compatible with the "Sistema Velcrabile 2VS" in order to carry a weapon or other accessories. Pockets in several dimensions on the front and double lateral pockets for various uses such as the carrying of radios, bottles and other items. Adjustable shoulder strap with an anti-slide system.



Measures: L37 x P11 x H27 cm



cod. **2B34** "CARGO LARGE TRAVEL BAG"

MULTI-POCKET BAG IN NYLON

Inner padded compartment for the protection of electronic instruments such as laptops, with an adaptable and removable multi-pocketed panel, a back pocket for documents with fastener and secret front pocket compatible with the "Velcro System 2VS pag 36" in order to carry a weapon or other accessories. Pockets in several dimensions on the front and double lateral pockets for various uses such as the carrying of radios, bottles and other items. Adjustable shoulder strap with an anti-slide system.



Measures: L55 x P31 x H30 cm



cod. **2B04** "POLICE TRAVEL BAG"

NYLON DUTY BAG

External pockets for radio, lights and all uses, internal compartments for pens, keys, cards and others uses. Adjustable large compartment, double carry with handle or shoulder strap.



Measures: L61 x P25,5 x H30,5 cm



cod. **2B05** "DUFFEL TRAVEL BAG"

MULTIPURPOSE NYLON BAG.

Great holding capacity central pocket with zipper. Double pockets on sides with zipper. Bottom pocket with zipper. Double handles on sides. Padded shoulder strap. Double upper handle



Measures: 65 X 35 X 30 cm



cod. **2B07** "TRAVEL SHOULDER BAG"

LARGE-CAPACITY MULTI POCKET BAG IN NYLON

Large central compartment lined with pockets on the closing leaves. Multi-use external pockets. Handles on sides and on top. Two shoulder straps and padding for carrying like a backpack.



Dimensions: L80 x P28 x H28 cm

cod. **2BT01**

SMALL

L55 x P35 x H25 cm (Cabin Sizes)



cod. **2BT02**

MEDIUM

L75 x P33 x H40 cm



cod. **2BT03**

LARGE

L85 x P35 x H45 cm



TRAVEL TROLLEY BAG AVAILABLE IN 3 SIZES.

- Main compartment with Zip mesh dividers outside multi pockets.
- Top Zip pocket inside and outside openable.
- Strong transport Handles on the sides and on the top.
- Zip closure with lockable sliders.
- Strong reinforced wheels and Cart System.
- Telescopic handle.





BLACK LABEL LINE

DUTY **D**

TACTICAL **T**

CONCEALMENT **C**

SPORT **S**

GLOVES **G**

+

GUIDE

cod
2BL02 "G/CASE 43"

PADDED LONG GUNS CASE

Three external zipped pockets.
External molle system.
Double carry handles and a special sling included.
Two internal parts with fasteninglaces system padded.
divided movable double mesh pockets
Color: black
Measures: 107x28x7 cm



cod
2BL01 "G/CASE 36"

PADDED LONG GUNS CASE

Three external zipped pockets.
External molle system.
Double carry handles and a special sling included.
Two internal parts with fasteninglaces system padded.
divided movable double mesh pockets
Color: black
Measures: 107x28x7 cm



cod
2BL03 "G/CASE 22"

PADDED SHORT GUNS CASE

One external zipped largest pocket.
External molle system. Double carry handles and a
concealment shoulders system on the back for backpack
carry. Internal fasteninglaces system on the side
Color: Black
Suggested for MP7, MP5, M12

Measures: 53x26x8 cm



cod
"P/BAG" **2BL11**

PADDED PISTOL CASE

One external zipped large pocket. External molle system.
Doble carryhandle. Two internal pocket.
Color: black
Measures 32x23x7 cm



cod
"V/PACK" **2BL21**

ALL USES SMALL BACKPACK

External large pocket.
Main compartment with internal pocket.Two sides mesh
pocket.
Padded back panneland shoulder harness
Adjustablecapacity and stability by laces
Color: black
Measures 37x26x13 cm





TACTICAL > GUNS CASES

cod.
2B50
cm 90

LIGHT PADDED NYLON GUN CASE



cod.
2B49
cm 105

cod.
2B54
cm 115

cod.
2B52
cm 78x27

PADDED NYLON GUN CASE

For Faamas / Beretta CX4 Storm and MP5, 2 utility pockets, shoulder strap.



cod.
2B53
cm 55x25

cod.
2B51
cm 105x30

PADDED NYLON GUN CASE

For SPAS 15/M16/Ar70/90, 3 utility pockets, shoulder strap.



cod.
2B57
cm 115x30

cod.
2FC11
cm 120

PADDED NYLON GUN CASE



cod.
2FC12
cm 130

cod.
2B55
cm 140x28

PADDED RECTANGULAR NYLON GUN CASE

Opens completely with 3 magazine holder and large utility pocket.



cod.
2B56
cm 115x28

TACTICAL > TACTICAL SLINGS

cod.
2BR21

TACTICAL SLING
Double hooks Mash model.
Double attachment system: one or two points
Special handle for fast adjustable length.



cod.
2BR16

ADVANCE SLING
Wide shoulder strap (5cm) for military or law enforcement use. Available with Crocodile snaphook cod. 2BR16 or with Snaphook M.A.S.H. cod. 2BRM16.



Crocodile Hook
2BR16

M.A.S.H. Hook
2BRM16



cod.
2BR15

MULTI POINT TACTICAL SLING
Wide 1 1/2" 3 points tactical sling in nylon webbing, crocodile snaphook.



cod.
2BR23

NYLON SLING FOR TACTICAL USE WITH NON-SLIP RUBBERIZED BANDS, ADJUSTABLE SLIDES.

Dual use with two points or one point, fast switchover by means of snap hook release fastening to 4 hole polymer plate. Pull-Strap release for fast transition from the rest to the shooting position. HK type snaphook with noise protection



cod.
2BR22

TACTICAL SLING
Crocodile double hooks with no noise system. "D" ring for better movement. Adjustable length.



cod.
2BR18

SINGLE POINT SLING
Single point sling with elastic bungee and strong hook on the shoulder or on the back.



cod.
2BR01

RIFLE SLING
Padded cordura rifle sling.



cod.
2BR10

TACTICAL SLING
The plastic buckle releaser carries quickly the weapon from a transport position to a Shoot position, double Kayak hook.



cod.
2BR19

CIRCULAR TACTICAL SLING WITH ADJUSTABLE STRAP
detachable weapon attachment extension with polymer buckle for immediate detachment.
Available with Crocodile snaphook cod. 2BR19 or with Snaphook M.A.S.H. cod. 2BRM19.



M.A.S.H. Hook
2BRM19



cod.
2BR20

STRONG NYLON SLING
With adjustable slider and reinforced snap-hooks. Just for Machine Guns as Beretta M12.



cod.
2BR07

COMBAT SLING
Dual option for wearing the firearm on the shoulder or on the back.



cod.
OP02

CHEST-BACK-SHOULDER PROTECTION FOR RIOT CONTROL

Outer covering material has high resistance to heat and wear and tear. Inner shockproof padding and positioned purposely to disperse the kinetic energy provoked by the impact of sticks and other piercing objects. Facility of movement thanks to the ergonomic design. Shoulder protection with plastic shockproof inserts. Adjustability through elastic and velcro for greater comfort and flexibility. It is not a bulletproof product. Available one size only.



cod.
OP03

GROIN PROTECTOR

Additional protection to the Upper Body protection Code OP02, attached by two laces closed by Velcro. Two elastic straps for a better stability.



cod.
OP01

ARM PROTECTION FOR RIOT CONTROL

Material has a high resistance to heat and wear and tear. Inner padding to protect the limbs from shock. Adjustability through elastic and velcro for greater comfort and flexibility. One size only.



cod.
OP00

KNEE-SHIN-FOOT PROTECTION FOR RIOT CONTROL

Knee-shin-foot protection, plastic shockproof parts with an inner system of expandable padding for maximum limb protection. Elastic velcro closure system for greater comfort and flexibility.



cod.
OE33

SILENT NEOPRENE KNEE PADS
Silent neoprene knee pads with padded and No-Slip rubber in the pres zone. Velcro adjustable double bands.

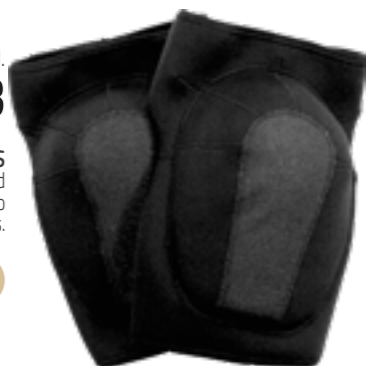

cod.
OE34

SILENT NEOPRENE ELBOW PADS
Silent neoprene elbow pads with padded and No-Slip rubber in the pres zone. Velcro adjustable double bands.



cod.
OE35

SILENT NEOPRENE KNEE/SHIN PADS
Silent neoprene knee/shin pads with padded. No-Slip rubber in the pres zone. Velcro adjustable double bands with plastic rings.



cod.
OE32

COTTON BALACLAVA



cod.
OE28

BALACLAVA IN NOMEX FOR DOUBLE USE
The bottom part can be folded below the chin and the upper part can be folded behind the neck.



cod.
OE27

NOMEX HOOD
Provides heat-flash protections..



cod.
"EXTREME-PRO" **OE40**

COMPACT KNEE PADS IN NYLON/CORDURA
with injection molded polymer cap, embracing shape, extra comfort padding, no-slip inner shell for greater stability, dual adjustable straps with quick fastening/unfastening mechanism.



cod.
"EXTREME-PRO" **OE41**

COMPACT ELBOW PADS IN NYLON/CORDURA
With injection molded polymer cap, embracing shape, extra comfort padding, and no-slip inner shell for greater stability, dual adjustable straps with quick fastening/unfastening mechanism.



cod.
OE30

NYLON AND NO-SLIP RUBBER KNEE PADS
Velcro adjustable double bands with plastic ring.



cod.
OE31

NYLON AND NO SLIP RUBBER ELBOW PADS
Velcro adjustable double bands with plastic ring.



cod.
OE25

EXTRA FLEXIBLE INJECTION POLYMER KNEE PAD
With inside metal adaptable system, no slip padded outside foam, double no slip elastic straps, adaptable also as inside pants padded use. Colors: black, green, coyote.



CONCEALMENT

HOLSTERS AND ACCESSORIES

118 / 124 INJECTION MOLDED POLYMER BELT HOLSTERS

125 / 131 THERMO MOLDED POLYMER BELT HOLSTERS

132 / 141 LEATHER OWB HOLSTERS

142 / 146 IWB HOLSTERS

147 / 150 NYLON BELT HOLSTERS

151 / 152 NYLON SHOULDER HOLSTERS

153 POLYMER SHOULDER HOLSTERS

154 / 157 LEATHER SHOULDER HOLSTERS

158 ANKLE HOLSTERS

159 BELLY BANDS

160 FANNY PACKS

161 / 163 VH BAGS COLLECTION



CONCEALMENT > INJECTION MOLDED POLYMER BELT HOLSTERS

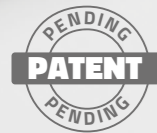

series **CCX8** "CONC. CAMA X"

INJECTION MOLDED POLYMER HOLSTER

Lower safety system that acts on the trigger guard. The system can be released by means of a thumb-operated lever on the inside of the holster in a "BACK & GO" movement. Retention screw for adjusting the friction of the holster on the weapon. Mounts an openable belt loop with the possibility of varying both the height and the inclination by means of 2 or 3 screws. The adjustable passage allows use on belts of all heights and on the MOLLE system. It can be mounted on all Vega Holster loops and kits.

International Patent.

AVAILABLE FOR
-Glock 17/18/19/22/23/31/32/45/47 -Sig Sauer P320 Full Size/Compact/M17/M18



COMPATIBLE KIT AND BELT LOOPS

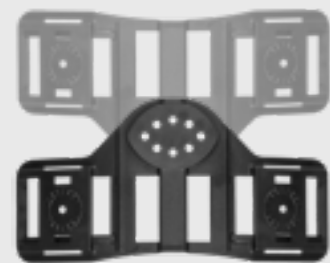

cod. **8K85**

UP&DOWN Belt loop, double uses, adjustment belt slots.



cod. **8K86** SHOULDER KIT

Modular Shoulder harness, soft polymer, multi holes, double platform for introducing holsters and accessories by rotating system or by screws system.



VEGAHOLSTER.COM

CONCEALMENT > INJECTION MOLDED POLYMER BELT HOLSTERS



series **CCH8** "CONC. CAMA"

PROFESSIONAL POLYMER INJECTION MOLDED HOLSTER

Retention level II. Retention screws and clip with double friction points. Index finger release of the front safety lock. Possibility of closing the bottom opening. Possibility of fully covered index finger safety lever. Possibility of inserting front protection for greater weapon safety. Loop opening with safety mechanism. It can be mounted on all Vega Holster loops and kits.

International Patent.

AVAILABLE FOR
-Glock 17/18/19/22/23/31/32/45/47 -Beretta APX, 92/98/A1 -H&K P30/P30L/30SK -H&K VP9/SFP9/SUB COMPACT



CCH8 with all included options mounted.



Partial cover



Total cover



Front shield OUT



Front shield IN



Removable closing cup (no all models)

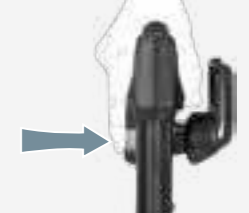

Release button



cod. **8K26**

Belt loop, adjustable belt size.



cod. **8K27**

Paddle loop, adjustable belt size.



cod. **8K87**

All use belt/molle loop that can be opened and is compatible with both DUTY BELTS and MOLLE SYSTEM



cod. **8K82**

Openable Belt Loop, adjustable belt size.

VEGAHOLSTER.COM

DUTY
TACTICAL
CONCEALMENT
SPORT
GLOVES
+

GUIDE



CONCEALMENT > INJECTION MOLDED POLYMER BELT HOLSTERS



series SHWC8 "CONC. SHOCKWAVE"

HOLSTER ADAPTED FOR CONCEALMENT USE IN SPECIAL INJECTION MOLDED POLYMER. Patented automatic safety mechanism on the trigger guard. When the pistol is inserted in to the holster the safety automatically activates. For removing the firearm pressing the lever found under the pistol grip, with middle finger in a natural position. Retention screw on the barrel. Compatibility with all kits. Double belt loops including (8K26 and 8K27).

AVAILABLE FOR Beretta 92/96/98 -Glock 17/18/19/22/23/31/32/37/38/45/47 -H&K USP Standard, USP Compact -Sig Sauer 2022



INCLUDED

PATENT PENDING

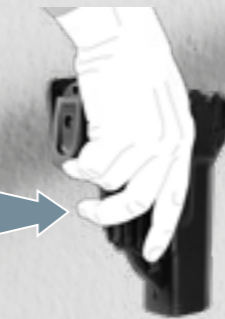

Safety system (A)

COMPATIBLE KIT AND BELT LOOPS

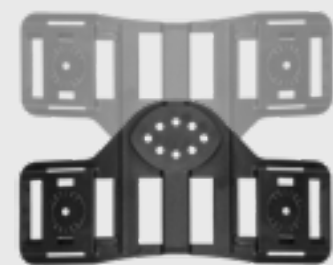

cod. **8K85**

UP&DOWN Belt loop, double uses, adjustment belt slots.



cod. **8K86** SHOULDER KIT

Modular Shoulder harness, soft polymer, multi holes, double platform for introducing holsters and accessories by rotating system or by screws system.



CONCEALMENT > INJECTION MOLDED POLYMER BELT HOLSTERS



series CCHU8 "CAMA UP&DOWN"

INJECTION MOLDED POLYMER HOLSTER

Retention level II. Upper opening with possibility of to introduce the front protection shield. Retention screws and clip with double friction points. Index finger release of the lower safety lock. Possibility of closing the bottom opening. Possibility of fully covered index finger safety lever. International patent. Mounted on UP&DOWN belt platform, allowing for extreme comfort thanks to its flexibility and shape. Adjustable belt loops through double barrels, slots for three different positions (straight, front cant, cross draw). Two carrying options: HIGH (under the shoulder), or LOW (below the waist). Compatible with Rotating System Accessories for simultaneous use on the same platform. It can be mounted on all Vega Holster loops and Kits.

AVAILABLE FOR -Glock 17/18/19/22/23/31/32/45/47 -Beretta APX stand./Compact, 92/98/A1 -H&K P30/P30L/30SK, H&K VP9/SFP9/SUB COMPACT



CCHU8 partial cover



CCHU8 without front shield



Lower position

High position



SHWU8 with accessories

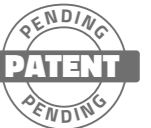

series SHWU8 "SHOCKWAVE UP&DOWN"

INJECTION MOLDED POLYMER HOLSTER

With trigger guard safety. It automatically engages when replacing the weapon into the holster and disengages by pressing on the lever, positioned under the weapon grip, with the middle finger. The holster is provided with a screw, which allows for adjusting weapon retention in the holster. Mounted on UP&DOWN belt platform, allowing for extreme comfort thanks to its flexibility and shape. Adjustable belt loops through double barrels, slots for three different positions (straight, front cant, cross draw). Two carrying options: HIGH (under the shoulder), or LOW (below the waist). Compatible with Rotating System Accessories for simultaneous use on the same platform. It can be mounted on all Vega Holster loops and Kits.

AVAILABLE FOR -Beretta 92/98 -Glock 17/18/19/22/23/31/32/37/38/45/47 -H&K USP Compact. e standard -Sig Sauer 2022

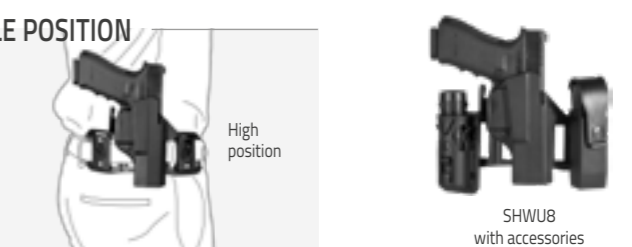

Lower position

High position

SHWU8 with accessories



cod. **8K26**

Belt loop, adjustable belt size.



cod. **8K27**

Paddle loop, adjustable belt size.



cod. **8K87**

All use belt/molle loop that can be opened and is compatible with both DUTY BELTS and MOLLE SYSTEM



cod. **8K82**

Openable Belt Loop, adjustable belt size.





CONCEALMENT > INJECTION MOLDED POLYMER BELT HOLSTERS



series **VJH8** "HYBRID"

INJECTION POLYMER MULTI USES HOLSTER
The holster can be used Inside, outside, for right and left hand users. Retention level I. Retention screws to adjust the pistol fit. Double belt loops included:
- belt loop with double slots, adjustable height and angle;
- clip with adjustable height and angle.



AVAILABLE FOR
-Glock 17/19/22/23/31/32/43/45/47, -All 1911' S size 3"-4"-5" with or without Picatinny rail



INCLUDED
cod. **8K50**
Rotating system clip
System for reducing belt passage.

INCLUDED
cod. **8K21**
Injection-molded special polymer belt loop
to wear the firearm near the body.
Adjustable double holes for belt of 60mm.
Maximum height. Multi-holes to adjust
height and inclination with screws.



series **VJHK8** "KIT CONFORT FOR HYBRID"

COMFORT KIT FOR HOLSTERS VJH8 SERIES
The rear part fixed with a double screw to the holster gives better side protection, preventing direct contact of the upper part of the weapon with the body.
The "appendix", fixed under the clip, coincides with the passage of the belt and helps to keep the grip of the weapon closer to the body, improving concealability even under T-shirts or tight jackets.
The kit comes in 3 sizes each suitable for a holster/weapon size.
Size 00 Large suitable for VJH858/VJH804
Size 01 Medium suitable for VJH809/VJH825
Size 02 Small suitable for VJH879/VJH878

CONCEALMENT > INJECTION MOLDED POLYMER BELT HOLSTERS



cod. **8BL20** "INSIDE BUNGY L/AUTO"

INSIDE HOLSTER IN INJECTION MOLDED RUBBERISED POLYMER
Tubular elastic system allows adjustment, easily adaptable to all Large Auto and Large Auto Compact weapons on the market.
Mounts a double-fastener internal clip for improved adherence at the side of the grip. Tilt adjustment and two possible heights.

AVAILABLE FOR
L/Auto - L/Auto Compact



cod. **8BL21** "INSIDE BUNGY S/AUTO"

INSIDE HOLSTER IN INJECTION MOLDED RUBBERISED POLYMER
Tubular elastic system allows adjustment, easily adaptable to all Small Auto weapons on the market.
Mounts a double-fastener internal clip for improved adherence at the side of the grip. Tilt adjustment and two possible heights.

AVAILABLE FOR
Small Auto





CONCEALMENT > INJECTION MOLDED POLYMER BELT HOLSTERS



cod. **8BL00** "BUNGY L/AUTO"

INJECTION MOLDED RUBBERISED POLYMER HOLSTER.

Adjustable through a TUBULAR ELASTIC system for an easy fit of all L/Auto and L/Auto compact weapons on the market. Removable lock system, through a tubular elastic, which can be inserted both on the weapon grip or on the upper part of the weapon hammer. Ambidextrous, mounted with a loop that can be opened for customizing both height and tilt through 2 or 3 screws. The adjustable passage permits use on belts with different heights and on MOLLE system.



cod. **8BL05** "BUNGY S/AUTO"

Same characteristics of 8BL00. Easily adaptable to all Small Auto weapons on the market.



cod. **8BL06** "BUNGY REV."

Same characteristics of 8BL00. Easily adaptable to all small Revolver 2-2 1/2" in J and k frames on the market.



cod. **8BL13** "BUNGY PANKY SLOT"

KIT OF TWO SLOTS FOR MOUNTING ON BUNGY 8BL00 HOLSTER. Belt height adjustment. For wearing close to the body.



CONCEALMENT > THERMO MOLDED POLYMER BELT HOLSTERS

series **VKK8** "KEEPER"

THERMO MOLDED POLYMER HOLSTER
Trigger guard molded shape for retention and retention screw on the barrel. Triple lined platform (polymer, cordura and alveolar cloth) for Molle tactical platform and belt.

AVAILABLE FOR
Beretta APX, 92/98 -Taurus PT92 -Sig Sauer 2022, Sig 226 with Rail, Sig 320 -H&K P30/P30L, VP9/SF, USP Compact -Glock 17/18/19/22/23/31/32/45/47, -Colt 1911'S -Walther P99Q/PPQ



series **VKX8** "AXIAL"

THERMO MOLDED POLYMER HOLSTER
Easy action safety system on the top and retention screw on the barrel. Reinforced belt loop in the screws point. Two opening and closing side loops by Velcro for a better attachment on belts or MOLLE platforms.

AVAILABLE FOR
Beretta APX, 92/98, PX4 -Taurus PT92 -Sig Sauer P320, 2022, 226 con rail -H&K VP9/SFP9, USP Standard & Compact, P30 -Glock 19/20/21/22/17/23/18 -Colt 1911'S -S&W M&P -Walther P99, P99Q, PPQ





series **VKU8 "UNDER JACKET"**

THERMO MOLDING POLYMER HOLSTER

Easy action safety system on the top and retention screw on the barrel. Double belt loops included: A) Paddle with adjustable inclination and height B) Holes belt loop with adjustable inclination and height.

AVAILABLE FOR
Beretta APX, 92/98, PX4, Brigadier/92A1/96A1/90Two -Taurus PT92 -Sig Sauer P320, 2022, 226 con rail -H&K VP9/SFP9, USP Standard & Compact, P30 -Glock 17/18/19/20/21/22/23/31/32/45/47 - 1911 S -Walther P99, P99Q, PPQ -Colt 1911 and all clones -FN Five Seven N, -CZ SP01 -Caracal F and C -Revolver S&W 3" and 4" K & L Frame -S&W M&P M2.0 -Springfield XD 5"

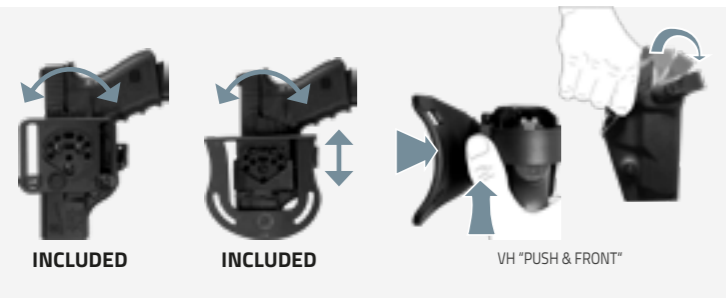

series **VKS8 "SHORT"**

COMPACT HOLSTER TO CARRY HIDDEN GUNS

This model is perfectly designed for those who want a compact holster to carry hidden guns with double-level-safety system so that firearms can automatically be inserted in the holster and released with an easy and natural hand's move. Compact. High resistant polymer. Internal cover for better protection of the firearm and less noise emission. VEGA PULL SIDE automatic safety system. Double holes belt loop included: A) Paddle with adjustable inclination and height. B) Holes belt loop with adjustable inclination and height. VEGATEK thermo-moulding.

AVAILABLE FOR
Beretta PX4/92/98/APX -Taurus PT92 -Sig Sauer 2022/226/P320/P320 Compact -H&K USP Stand./Compact/P30 -Glock 17/18/19/22/23/31/32/45/47 -Walther P99.

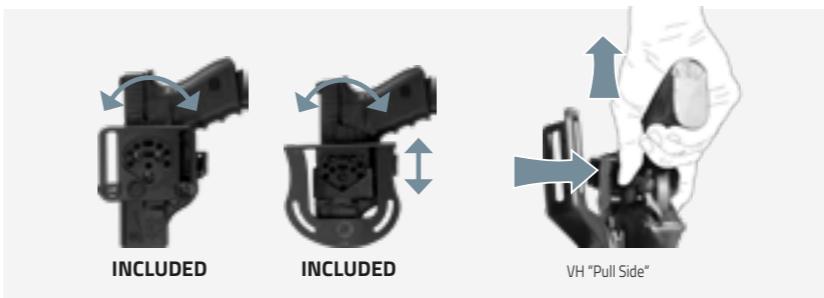

series **VKR8 "RESCUE"**

POLYMER HOLSTER WITH INSIDE SAFETY MECHANISM.

At the holstering the safety enter automatically. Double belt supports: paddle and standard double holes belt loop.

AVAILABLE FOR
Beretta PX4/92/98/APX -Taurus PT92 -Sig Sauer 2022, 226 -H&K USP Stand./Compact/P30 -Glock 17/18/19/22/23/31/32/45/47.

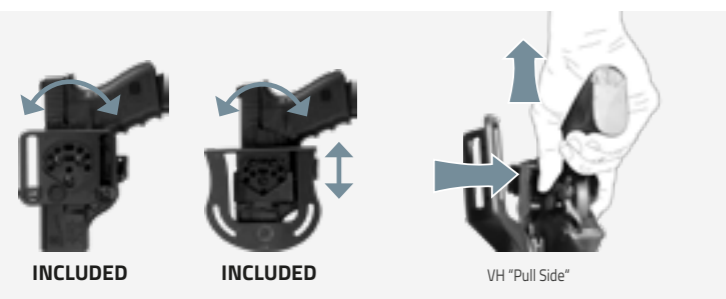

series **VKI8 "INDEX"**

COMPACT DESIGN FOR BETTER CONCEALMENT

The safety system automatically engages once the weapon is placed in the holster and disengages with a simple and natural movement of INDEX finger while drawing the weapon.

Thermoformed in polymer and internal suede lining for better weapon protection. Double loop system included: A) paddle with adjustable tilt and height; B) loop eyelet with adjustable tilt and height.

AVAILABLE FOR
Beretta 92/98 -Glock 17/19/22/23/31/32/45/47 -H&K P30 all sizes and VP9/SFP9 all sizes

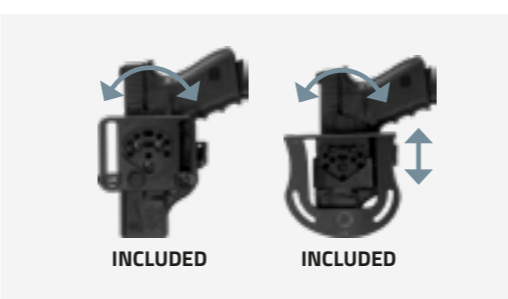



CONCEALMENT > THERMO MOLDED POLYMER BELT HOLSTERS

series **SHW08** "EASY"

INJECTION MOLDING POLYMER HOLSTER
Retention screw on the trigger guard. Double belt loops included: A) Paddle with adjustable inclination and height B) holes belt loop with adjustable inclination and height.

AVAILABLE FOR
-Walther P99Q, PPQ

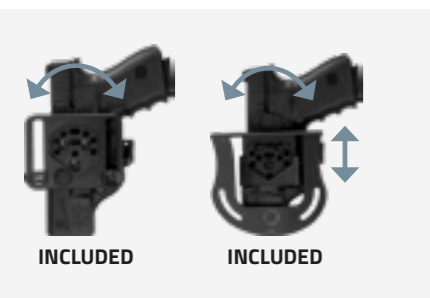

series **VKH8** "HALF"

ESSENTIAL HOLSTER TO REDUCE THE OVERALL DIMENSION
Thicker polymer. Retention screw on the jumper and on the barrel. Trigger guard molded shape for better retention. Double belt loops included: A) Paddle with adjustable inclination and height B) holes belt loop with adjustable inclination and height.

AVAILABLE FOR
Beretta APX, 92, 96, 98, PX4 standard and compact -Colt 1911' S all sizes -Glock 17/19/22/23/26/27/31/32/37/38/45/47V -H&K SFP9, USP Standard, USP Compact, P30 -Sig Sauer 2022, 226 -Walther P99 last edition -Springfield XDM

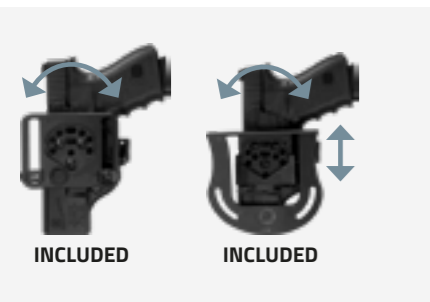

CONCEALMENT > THERMO MOLDED POLYMER BELT HOLSTERS

series **VKF8** "FAST"

PRACTICAL - RAPID - EXTREMELY SAFE HOLSTER
This model is perfectly designed for those who want a practical, rapid as well as an extremely safe holster. Thicker polymer. Double retention screw operating on the jumper and the barrel. Watertight support on the jumper for better safety. Double holes belt loop included: A) Paddle with adjustable inclination and height. B) Holes belt loop with adjustable inclination and height. VEGATEK thermo-moulding.

AVAILABLE FOR
Beretta PX4/92/98, -Colt 1911'S, -Taurus PT92, -Sig Sauer 2022, -H&K USP Stand./Compact, -Glock 17/19/22/23/31/32/45/47, -Walther P99

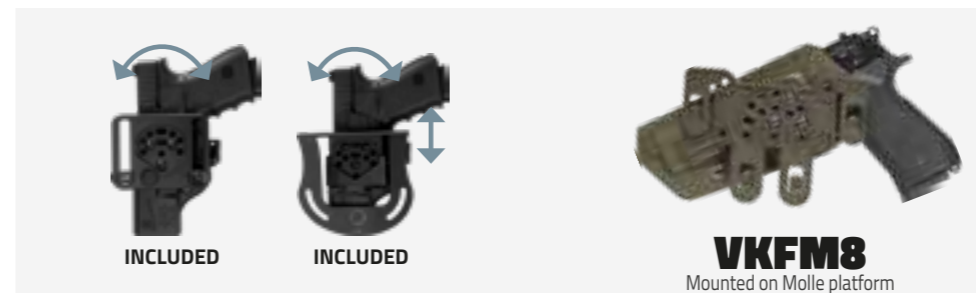

series **VKO8** "OPEN"

series **VKOS8** "SPORT"

As VKO8 Mounted with Sport Lower Loop for description see pag. 168.

THERMO MOLDED POLYMER OPEN HOLSTER
Double retention screw operating on the jumper and the barrel. Trigger guard molded shape for better retention. Double holes belt loop included: A) Paddle with adjustable inclination and height. B) Holes belt loop with adjustable inclination and height. VEGATEK thermo-moulding.

AVAILABLE FOR
Beretta APX, 92, 96, 98, PX4 -Colt 1911 e simili/1911's (and clones) -Glock 17/19/22/23/31/32/37/38/45/47 -H&K SFP9, VP9/SFP9, USP Standard, USP Compact, P30 -Sig Sauer 226, 320, 2022 -Walther P99 last edition -CZ SP01 -Springfield XDM -Tanfoglio Gold Match/Limited Custom/Stock 2/Stock 3P/Custom P/Force NG





CONCEALMENT > THERMO MOLDED POLYMER BELT HOLSTERS

series **FL8** "PANCAKE FLAT HOLSTER"

DOUBLE MATERIAL PANCAKE HOLSTER
Front Polymer for easy holstering and long life.
Leather on the back for better comfort and contour.
Adjustable retention screw.
3 slots for different angles.

AVAILABLE FOR
Beretta APX, PX4/92/98 -Taurus PT92 -Sig Sauer 320, 2022/226 with Rail -H&K VP9/ SF, USP Compact/P30 -Glock 19/22/17/23/18 -Colt 1911'S -Walther PPQ/P99Q.

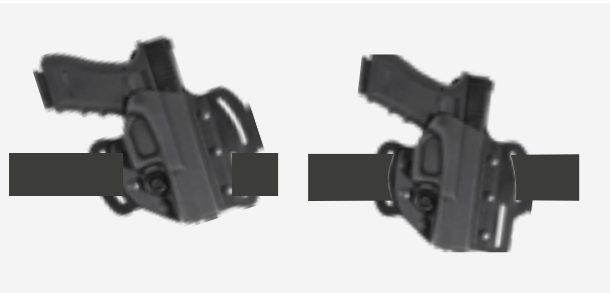
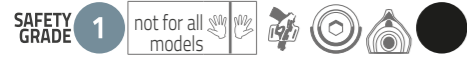

series **VHH8** "MIX PANCAKE"

THERMO MOLDED POLYMER HOLSTER WITH SOFT REAR PART
Adjustable retention screws.
Double rubber belt loop, adjustable in height and position.

AVAILABLE FOR
Beretta APX, 92 / 98FS -Glock 17/19/23/22/31/32/45/47 -H&K VP9/SFP9, USP Standard & Compact, P30 -Sig Sauer 320, 2022, 226 with or without rail -Colt/- Springfield 1911' S 5" with or without rail



series **VHHR8** "SOLID PANCAKE"

THERMO MOLDED POLYMER HOLSTER WITH RIGID REAR PART
Retention screws to adjust the pistol fit.
Double rubber belt loop, adjustable in height and angle.

AVAILABLE FOR
-Glock 17/19/22/23/31/32/45/47 -Beretta APX, -H&K VP9/SFP9, -Sig Sauer SIG 320



CONCEALMENT > THERMO MOLDED POLYMER BELT HOLSTERS

series **IF8** "INSIDE FLAT"

INSIDE UNDER SHIRT HOLSTER.
Front Polymer for easy holstering and long life.
Padded Nylon on the back for better comfort and contour.
Adjustable retention screw.
Double polymer clip with adjustable angle

AVAILABLE FOR
Beretta APX, PX4/92/98 -Taurus PT92 -Sig Sauer SIG 320, 2022/226 with Rail -H&K VP9/SF, USP Compact/P30 -Glock 17/18/19/22/23/31/32/43/45/47 -Colt 1911'S -Walther PPQ/P99Q.



series **IR8** "INSIDE RESCUE"

INSIDE THERMO MOLDING POLYMER HOLSTER
Retention screw on the trigger guard. Double rubber lace to attach on the belt.

AVAILABLE FOR
Beretta PX4, 92, 98 -Glock 17/18/19/22/23/26/27/31/32/45/47 -Colt 1911'S (and clones) with Rail and no Rail -Walther P99Q, PPQ -H&K USP Compact



series **IU8** "INSIDE UNDER SHIRT"

INTERNAL HOLSTER IN THERMO-MOLDED POLYMER
with injection molded polymer clip, which permits cant and carrying adjustment, under or over shirt for complete concealment.

AVAILABLE FOR
-Walther P99Q, PPQ -Glock 19/22/26/27/31/32/43/45/47 -Beretta 92/98, APX -H&K VP9/SFP9, -Glock 26/42, -Sig Sauer 2022





series

SI1

CONCEALMENT HOLSTER

The safety system automatically engages once the weapon is placed in the holster and disengages with a simple and natural movement of INDEX finger while drawing the weapon.
Thermoformed in leather
Double slot for close to body fit and weapon grip above belt line

AVAILABLE FOR

Beretta 92/98 -Sig Sauer 2022, -Glock 17/19/22/23/31/32/45/47, -H&K VP9/SFP9



series

SU1

BELT LEATHER HOLSTER

Belt leather holster with automatic safety system. Mounts inside the automatically safety system Vega Pull Side: Reinserting the firearms into the holster the safety catch which acts on the trigger guard automatically reacted; to pull out the holster simply pull side the inside lever, it is possible to insert a second level of safety with a movable catch that block the safety level. Including double techno polymer belt support systems: 1° VH-Paddle with the possibility of to adjust the inclination angle, the high of the holster respect the belt and the belt retention high. 2° VH-Holes with double loops and the possibility of to adjust the Inclination angle, the high of the holster respect the belt and the belt retention high.

AVAILABLE FOR

Beretta 92, 98 -Glock 17/19/22/23/26/27/31/32/45/47 -H&K USP, USP COMPACT, P2000 -Sig Sauer 2022 -Walther P99

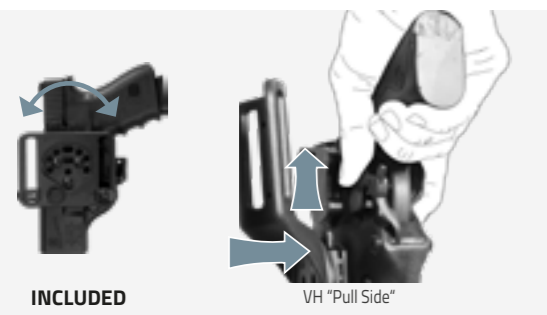

series

TS1

BELT HOLSTER WITH AUTOMATIC SAFETY SYSTEM

Belt leather holster with automatic safety system.Techno holes belt loop system. Two uses: on the right side or in the cross draw position.

AVAILABLE FOR

Beretta 92, 98 -Glock 17/19/22/23/31/32/45/47 -H&K VP9/SFP9, USP, USP Compact, P2000 -Sig Sauer 2022 -Walther P99

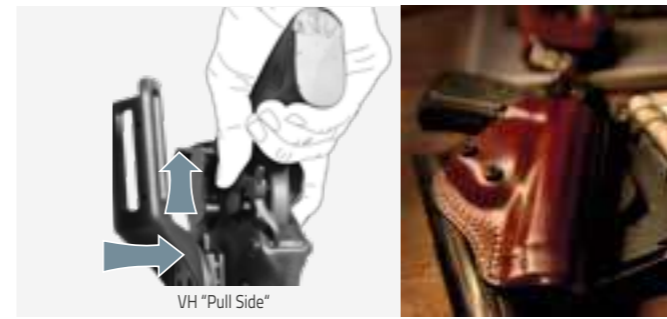

series

NS1

BELT HOLSTER UNCOVERED FULL BARREL WITH AUTOMATIC SAFETY SYSTEM

Belt leather holster uncovered full barrel with automatic safety system.Techno holes belt loop system. Two uses: on the right side or in the cross draw position.

AVAILABLE FOR

Beretta 92, 98 -Glock 17/19/22/23/26/31/32/45/47 -H&K USP, USP Compact, P2000, VP9/SFP9 all sizes -Sig Sauer 2022 -Walther,P99





series **TU1**

LEATHER SIDE HOLSTER

Adjustable retention screw.
Double carry system included:
1° Paddle with adjustment angle and height.
2° Double slots belt loop with adjustment angle and height.

AVAILABLE FOR
Beretta 92/98, 84, PX4 - Colt Government, Detective, Python 21/2", 4" -King Cobra 4"
-Glock 17/19/20/21/22/23/26/27/30/31/32/45/47 -Ruger GP100 4", SP101 2 1/4"
-H&K USP/USP COMPACT, P2000 -Sig Sauer 2022 -S&W Rev. J Frame 2", K Frame 2 1/2" 3"
4", L Frame 4" -Springfield 1911 'S -Taurus PT92, -Rev 2" -Walther P99/PPS



series **FT1**

MOLDED LEATHER HOLSTER

Polymer Openable Belt loop, adjustable angle and belt size passage. Quick release thumb snap.
Compact shape for greater comfort and concealment.

AVAILABLE FOR
Beretta 92/98/PX4 -Glock 17/19/22/23/31/32/45/47 -Colt 1911 & Cloni -Sig Sauer 226 with Rail

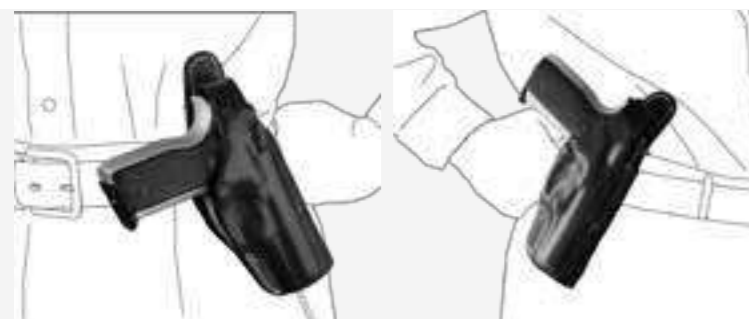

series **T1**

QUICK RELEASE HOLSTER

Leather belt holster, quick release. Two uses: inclined on the right side or cross draw.

AVAILABLE FOR
Beretta 92/98, 84, 8000, 9000, PX4, 90TWO -Browning High Power -Colt Detective, Python 2 1/2", 4", 6", King Cobra 4" 6", Anaconda 4" -CZ 75, 85, 83 -Glock 17/19/20/21/22/23/26/27/30/31/32/45/47 -H&K USP, USP Compact, P2000 -Sig Sauer P220, 226, 228, 229, 230 -Ruger GP100 4", SP101 2 1/4" -S&W Auto 3 1/2" 4", Rev. J Frame 2", K Frame 2 1/2" 3" 4" 6", L Frame 4" 6", N Frame 3" 4", 6" -Springfield 1911's -Tanfoglio GT21, Force -Taurus PT92, Rev 2"



series **N1**

3 USES HOLSTER

3 uses leather belt holster, quick release. You can use: inclined on the right side, cross draw or horizontal on the back.

AVAILABLE FOR
Beretta APX, 92/98, 84, 8000, 9000, PX4, 90TWO -Browning High Power -Colt Government -Glock 17/19/20/21/22/23/26/27/30/31/32/42/43/45/47 -H&K VP9/SFP9, USP, USP Compact, P30 -Sig Sauer P320, 2340, 2009, 2022, 228, 229, 225 -S&W M&P M2.0 5", Auto 3 1/2" 4", 1911'S -Springfield 1911's, XD -Tanfoglio GT21, Force, Police, Pro -Taurus PT92, 24/7, 1911's -Walther P99, PPK, PP, PPS -CZ SP01





series
FH1

QUICK RELEASE HOLSTER
Belt Leather Holster, quick release, with plastic techno-loops. Two uses: on the right side or in the cross draw position.

AVAILABLE FOR
Beretta 92, 98, PX4, 90TWO -Glock 17/19/22/23/31/32/45/47 -H&K USP, USP Compact, P2000 -Colt all 1911's -Sig Sauer 2022 -Walther P99



series
HB1

OPEN BELT HOLSTER
Open belt leather holster with 2 belt loops. Inclined on the right side position.

AVAILABLE FOR
Beretta 92, 98, 8000 -Colt Government -Glock 17/19/20/21/22/23/25/45/47 -Sig Sauer P220 226, 228, 229 -S&W Auto 3 1/2", 4" -Springfield 1911' S -Tanfoglio GT21, Force -Taurus PT92



series
HA1

OPEN BELT HOLSTER
Open belt leather holster with 2 belt loops. Inclined on the right side position.

AVAILABLE FOR
HA150 -Revolver 2 1/2" castello/frame K/L
HA151 -Revolver 4" castello/frame K/L



series
H1

QUICK RELEASE HOLSTER
Belt leather holster, quick release, 3 belt loops. Two uses: inclined on the right side or cross draw.

AVAILABLE FOR
Beretta APX, 92/98, 84, 8000, 9000, PX4, 90TWO -Browning Haigh Power -Colt Government, Detective, Python 2 1/2", 4" King Cobra 4", Anaconda 4" -CZ 75, 85, 83 -Glock 17/19/20/21/22/23/26/27/30/31/32/43/45/47 -H&K VP9/SFP9, USP, USP Compact, P2000, P30 -Ruger GP100 4", SP101 2 1/2" -Sig Sauer P220, 226, 228, 229, 230, 320, 2340, 2022 -S&W M&P M2.0 5" -S&W Auto 3 1/2"-4", Rev. J Frame 2", K Frame 2 1/2"-4", L Frame 4", N Frame 3"-4" -Springfield 1911's -Tanfoglio,GT21, Force -Taurus PT92, Rev 2" -Walther P99, PPK, PPS -All 1911's -CZ SP01



cod.
H199

QUICK RELEASE HOLSTER
Belt lined leather holster, quick release snap, 4 belt loops. Three uses: on the right side high or low or cross draw position

AVAILABLE FOR
Beretta 92/98 -> cod. H199





series **HL1**

PANCAKE HOLSTER FOR PISTOLS WITH LIGHTS/LASER

Molded in top quality leather.
Triple Belt loops for two uses:
1° Inclined on the rights
2° Cross Draw position.
Thumb snap with inside steel reinforce.

AVAILABLE FOR
-Glock 17 with Surfire X400, 22 -Sig Sauer 226 with Surfire X400



series **HLV1 "VIRIDIAN LIGHT"**

PANCAKE HOLSTER FOR PISTOLS WITH VIRIDIAN LIGHT

Molded in top quality leather.
Triple Belt loops for two uses:
1° Inclined on the rights
2° Cross Draw position.
Thumb snap with inside steel reinforce.
Inside special mechanism allows Viridian light to switch on when the Pistol is pull out and to switch off when the Pistol return in the holster.

AVAILABLE FOR
-Glock 17 / 22 with Viridian X5L / X5L-R -Sig Sauer Sig 320 with Viridian X5L/X5L-R

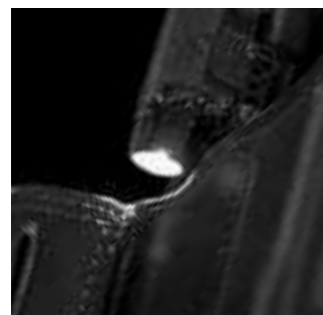

series **NC1**

UNCOVERED FULL BARREL HOLSTER

Leather belt holster, uncovered full barrel. Inclined on the right side.

AVAILABLE FOR
Beretta 92/98, 84, 8000 -Colt Government -Glock 17/19/20/21/22/23/30/31/32/45/47
-Sig Sauer 228,229 -Springfield,1911' S -Tanfoglio,GT21, Force -Taurus,PT92



series **NB1**

BACK OPEN HOLSTER

Leather belt holster, open. Inclined back position.

AVAILABLE FOR
Beretta 92/98, 84, 8000 -Glock 19/23/31/32/45/47 -Sig Sauer 225, 228, 229 -Tanfoglio GT21, Force -Taurus PT92



series **NF1**

QUICK RELEASE BACK HOLSTER

Leather belt holster, quick release, inclined back position.

AVAILABLE FOR
-Colt Detective, Python 2 1/2" -Ruger SP101 2 1/4" -S&W Rev. J Frame 2", K Frame 2 1/2", L Frame 2 1/2" -Taurus Rev 2"



series
F1

BELT LEATHER HOLSTER WITH QUICK RELEASE
Belt leather holster uncovered full barrel with quick release.
2 belt loops. Inclined on the right side position.

AVAILABLE FOR
Beretta 92/98, 84, 8000, 9000, PX4, 90TWO - **Browning** High Power - **Colt** Government, Detective, Python 2½"
- **CZ** 75, 85, 83 - **Glock** 17/19/20/21/22/23/26/27/30/31/32/43/45/47/48 - **H&K** USP, USP Compact, P2000
- **Ruger** SP101 2½", GP100 4" - **Sig Sauer** P220, 226, 228, 229, 230, 2340, 2009, 2022 - **S&W** Auto 3 ½" 4", Rev. J
Frame 2", K Frame 2½" 4" - **Springfield** 1911'S, XD - **Tanfoglio** GT21, Force - **Taurus** PT92, 24/7, Rev 2"
- **Walther** P99, PP, PPS - All 1911's



series
FD1

BELT LEATHER HOLSTER WITH ELASTIC RETENTION
Leather belt holster, uncovered full barrel, elastic retention, 2 belt loops. Inclined on the right side position.

AVAILABLE FOR
Beretta 92/98, 84, 8000, 9000, PX4, 90TWO - **Browning** High Power - **Colt** Government, Detective, Python 2½" - **CZ**
75, 85, 83 - **Glock** 17/19/20/21/22/23/26/27/30/31/32/43/45/47/48 - **H&K** USP, USP Compact, P2000 - **Ruger**
SP101 2½", GP100 4" - **Sig Sauer** P220, 226, 228, 229, 230, 2340, 2009, 2022 - **S&W** Auto 3 ½" 4", Rev. J Frame 2", K
Frame 2½" 4" - **Springfield** 1911'S, XD - **Tanfoglio** GT21, Force - **Taurus** PT92, 24/7, Rev 2"
- **Walther** P99, PP, PPS - All 1911's.



series
FB1

BELT LEATHER HOLSTER UNCOVERED FULL BARREL
Belt leather holster uncovered full barrel. 2 belt loops. Inclined on the right side position.

AVAILABLE FOR
Beretta PX4, 92/98, 84, 8000, 9000 - **Browning** High Power - **Colt** Government, Detective,
Python 2½" - **CZ** 75, 85, 83 - **Glock** 17/19/20/21/22/23/26/27/30/31/32/45/47/48 - **H&K** USP, USP Compact,
P2000 - **Ruger** SP101 2½" - **Sig Sauer** P220, 226, 228, 229, 230, 2340 - **S&W** Auto 3 ½",
4", Rev. J Frame 2", K Frame 2½" - **Springfield** 1911'S - **Tanfoglio** GT21, Force - **Taurus** PT92, Rev
2" - **Walther** P99, PP, PPS.



series
FA1

BELT LEATHER HOLSTER UNCOVERED FULL BARREL
Belt leather holster uncovered full barrel. Elastic retention. 2 covered belt loops. Inclined on the right side position.

AVAILABLE FOR
Glock 17/22/19/23/18 - **Beretta** PX4/APX/92/98/A1 - **H&K** P30/P30L/VP9/SFP9



series
FV1

OPEN SNAPS HOLSTER
Belt Leather Holsters, uncovered full barrel,
open snaps loops. Right side position.

AVAILABLE FOR
Beretta 92/98 - **Glock** 17/22/19/23
- **H&K** USP, USP Compact, P2000 - **Colt**
all 1911's - **Walther** P99



series
NE1

UNCOVERED FULL BARREL HOLSTER
Leather belt holster, uncovered full barrel. Two uses: on the right side or
in cross draw position.

AVAILABLE FOR
Beretta 92/98, 84, 8000, 9000 - **Browning** High Power - **Colt** Government, - **CZ** 75,
85, 83 - **Glock** 17/19/20/21/22/23/26/27/30/31/32/45/47/48 - **H&K** USP, USP
Compact, P2000 - **Sig Sauer** P220, 226, 228, 229, 2009, 2022, 230 - **S&W** Auto 3 ½", 4"
- **Springfield** 1911's, XD - **Tanfoglio** GT21, Force - **Taurus** PT92, 24/7 - **All** 1911's model
- **Walther** PPS



series
HC1

ADJUSTABLE RELEASE HOLSTER
Belt leather holster, adjustable release, 2 belt loops. Right side position.

AVAILABLE FOR
Baby Auto, -> cod. HC180 - **Small Auto**, -> cod HC181





series
IH1

DOUBLE USES LEATHER MOLDED HOLSTER

Inside carry by polymer clip or outside by double loops uses. Molded with the pistol shape for a better re-holstering. BPS rear protections system preventing contact of the weapon directly on the side (to prevent tangling in the clothes or prevent abrasion due to contact with weapons).

AVAILABLE FOR

Beretta APX, 92/98, PX4 -**Taurus** PT92 -**H&K** VP9/SFP9, USP Compact, P30 -**Glock** 17 /18/19/22/23/26/27/31/32/45/47/48, -**Colt** 1911'S and Clones with Rail and No rail -**Walther** P99Q, PPQ -**Sig Sauer** P320 -**S&W** M&P M2.0 5"



series
IF1

DOUBLE USES LEATHER HALF HOLSTER

Inside carry by polymer clip or outside carry by double belt loops. With reinforced elastic retention sytem. It is possible to use the same holster for right or left hand users.

AVAILABLE FOR

L/Auto, L/Auto Compact, M/Auto



series
UC1

INSIDE HOLSTER.

Under Shirt belt Holster for maximum occultament. Thermo molded top quality natural leather. Injection Molding Belt Clip with double Hooks for a better stability. Adjustment angle possibility for a Cross Draw or Right side uses.

AVAILABLE FOR

Beretta 92/98, PX4 -**Colt** 1911'S and Clones with Rail and No rail -**Glock** 17/22/19/23/26/27/31/32/45/47/48 -**H&K** USP Compact -**Taurus** PT92



series
IC1

INSIDE HOLSTER.

Natural leather belt Inside holster, with double lace belt loop and safety snaps.

AVAILABLE FOR

Beretta 92/98, 84, 8000 -**Colt** Detective, Python 2 1/2" -**Glock** 19/23/26/27/31/32/45/47 -**Ruger** SP101 2 1/4" -**Sig Sauer** P225, 228, 229 -**S&W** Rev. J Frame 2", K Frame 2 1/4" -**Tanfoglio** GT21, Force -**Taurus** PT92, Rev 2"





CONCEALMENT > IWB HOLSTERS

series

I1

QUICK RELEASE HOLSTER

Leather belt holster, quick release. four uses: inside or outside, right and left hand. Available with steel clip: ID1 series.

AVAILABLE FOR

L/Auto - L/Auto Compact - M/Auto



steel clip

series

IB10

INSIDE HOLSTER IN ANTI-SLIP SYNTHETIC FABBRIC

Long shape on the back. Polymer Sewing clip."

AVAILABLE FOR

L/Auto - L/Auto Compact - M/Auto



series

IE10

INSIDE POCKET HOLSTER

Inside pocket holster in anti-slip fabric, for right and left hand.

AVAILABLE FOR

Small Auto cod. IE1001 - Baby Auto cod. IE1001 - Rev. 2" cod. IE1002



cod

10P09

INSIDE MAGAZINE CASE IN ANTI SLIP SYNTHETIC FABBRIC

Long shape on the back. Polymer Sewing clip



cod

3P09

INSIDE MAGAZINE CASE IN SUEDE LEATHER

Long shape on the back. Polymer clip..



CONCEALMENT > IWB HOLSTERS

series

IB3

INSIDE HOLSTER

Suede belt holster. Inside position. Right and left hand. Polymer clip.

AVAILABLE FOR

L/Auto - L/Auto Compact - M/Auto - Small Auto - Baby Auto - Rev. 2", 2 1/2", 4"



series

IR3

INSIDE HOLSTER.

Suede holster for better comfort, inside carry with polymer clip. Choice of 3 different cants through three dedicated slots. Right or left hand.

AVAILABLE FOR

-Small Auto -M/Auto -L/Auto Compact, L/Auto -Revolver 2", 21/2".



series

IU3

UNDER SHIRT BELT HOLSTER FOR MAXIMUM OCCULTAMENT

Suede top quality leather. Injection Molding Belt Clip with double Hooks for a better stability. Adjustment angle possibility for a Cross Draw or Right side uses.

AVAILABLE FOR

L/Auto - L/Auto Compact - M/Auto - Small Auto - Rev. 4"



series

IA3

QUICK RELEASE HOLSTER

Suede belt holster, quick release, four uses: inside or outside, right or left hand. Available with steel clip: ID3 series.

AVAILABLE FOR

L/Auto - L/Auto Compact - M/Auto



steel clip



CONCEALMENT > IWB HOLSTERS

series **IU2**

UNDER SHIRT HOLSTER
Under shirt Nylon Holster for maximum concealment.
Polymer Belt clip with double hooks for better stability. Adjustment angles.

AVAILABLE FOR
L/Auto - L/Auto Compact - M/Auto - Small Auto - Rev. 4"



series **IF2**

CORDURA MOLDED HOLSTER
Inside carry by polymer clip. Molded with the pistol shape for a better re-holstering. BPS rear protection system preventing contact of the weapon directly on the side (to prevent tangling in the clothes or prevent abrasion due to contact with weapons).

AVAILABLE FOR
Beretta 92/98 -Taurus Pt 92 -H&K USP Stand & Compact, P2000
-Glock 19/22/17/23/18, 1911'S



series **IA2**

CORDURA BELT HOLSTER
Cordura belt holster, quick release. Four uses: inside, outside, right or left hand. Available with steel clip: series ID2.

AVAILABLE FOR
L/Auto - L/Auto Compact - M/Auto



series **I2**

CORDURA INSIDE BELT HOLSTER
Cordura inside belt holster, for right and left hand.

AVAILABLE FOR
L/Auto - L/Auto Compact - M/Auto - Small Auto - Baby Auto - Rev. 2", 2 1/2", 4"



CONCEALMENT > NYLON BELT HOLSTERS

series **T2**

CORDURA BELT HOLSTER
Cordura belt holster, adjustable quick release. Polymer belt loop. Two uses: inclined on the right side or cross draw.

AVAILABLE FOR
L/Auto -L/Auto Compact -M/Auto -S/Auto -Rev. 2" 2 1/2" 4" 6"



series **TM2**

CORDURA BELT HOLSTER
Adjustable quick release. Ambidextrous TECHNO belt loop two uses: inclined on the right side or cross draw position. Magazine case in front

AVAILABLE FOR
L/Auto -L/Auto Compact



series **FA2**

NYLON BELT HOLSTER
Nylon belt holster. Uncovered full barrel. Adjustable quick release.

AVAILABLE FOR
L/Auto -L/Auto Compact -M/Auto -Auto, -Rev. 2", 2 1/2", 3", 4"



series **FB2**

NYLON BELT HOLSTER WITH MAGAZINE CASE
Nylon belt holster with magazine case, quick release. Inclined on the right side, ambidextrous.

Available for:
L/Auto - L/Auto Compact





CONCEALMENT > NYLON BELT HOLSTERS

series SU2

BELT THERMO MOLDED CORDURA HOLSTER

With automatic safety system. Mounts inside the Automatically safety system Vega Pull Side: Reinserting the firearms into the holster the safety catch which acts on the trigger guard automatically reacted; to pull out the holster simply pull side the inside lever, it is possible to insert a second level of safety with an a movable catch that block the safety level. Including double techno polymer belt support systems: 1° VH-Paddle with the possibility of to ad just the Inclination angle, the high of the holster respect the belt and the belt retention high. 2° VH-Holes with double loops and the possibility of to adjust the Inclination angle, the high of the holster respect the belt and the belt retention high.

AVAILABLE FOR
Beretta 92/98 -Glock 17/19/22/23/26/27/31/32/45/47 -H&K USP/USP COMPACT, P2000 -Sig Sauer 2022 -Walther P99



INCLUDED



series ST2

MOLDED FULL HOLSTER WITH SAFETY SYSTEM

Thermo molded Nylon Holster with "Pull Side" safety mechanism. Polymer belt loops with three holes for Right side carry or Cross draw carry.

AVAILABLE FOR
Beretta 92/98 -Glock 17/19/22/23/26/27/31/32/45/47 -H&K VP9/SFP9, P30, USP/ USP COMPACT, P2000 -Sig Sauer P228/229, P220, 226, PRO 2340, 2009, 2022 -Walther P99



series SN2

MOLDED HALF HOLSTER WITH SAFETY SYSTEM

Thermo molded Nylon Holster with "Pull Side" safety mechanism. Polymer belt loops with three holes for Right side carry or Cross draw carry.

AVAILABLE FOR
Beretta 92/98 -Glock 17/19/22/23/26/27/31/32/45/47/48 -H&K VP9/SFP9 all sizes, P30 all sizes, USP/USP COMPACT, P2000 -Sig Sauer P228/229, P220, 226, PRO 2340, 2009, 2022 -Walther P99



CONCEALMENT > NYLON BELT HOLSTERS

series TU2

CORDURA BELT HOLSTER

Cordura molded belt holster with a thumb snap lace with "Vega stop snap" system. Including double techno polymer belt support systems: 1° VH-Paddle with the possibility of to ad just the Inclination angle, the high of the holster respect the belt and the belt retention high. 2° VH-Holes with double loops and the possibility of to adjust the Inclination angle, the high of the holster respect the belt and the belt retention high.

AVAILABLE FOR
Beretta 92/98, 84, PX4 -Colt Detective, Python 21/2", 4", King Cobra 4" -Glock 17, 19, 22, 23, 26, 27, 30, 31 -Ruger GP100 4", SP101 2 1/4" -H&K USP/USP COMPACT, P2000 -Sig Sauer 2022 -S&W Rev. J Frame 2", K Frame 2 1/2" 3" 4", L Frame 4" -Taurus PT92, Rev 2" -Walther P99 -All 1911'S L/Auto - L/Auto Compact - M/Auto - Rev. 2", 3", 4"



INCLUDED



series FH2

CORDURA BELT HOLSTER

Molded cordura holster, adjustable quick release with safety system, with techno holes belt loops. Two uses: inclined on the right side or cross draw.

AVAILABLE FOR
L/Auto - L/Auto Compact - Rev. 4"



series NE2

CORDURA BELT HOLSTER

Molded cordura half holster. Adjustable quick release, uncovered full barrel. TECHNO HOLES belt loop two uses: inclined on the right side or cross draw position.

AVAILABLE FOR
L/Auto - L/Auto Compact - M/Auto - Rev. 2", 3", 4"





CONCEALMENT > NYLON BELT HOLSTERS

series

FT2

CORDURA BELT HOLSTER

Molded cordura holster, adjustable quick release with VEGA STOP SNAP safety system. Inclined on the right side position.

AVAILABLE FOR

L/Auto - L/Auto Compact - M/Auto - Rev. 2", 4"



series

FF2

CORDURA BELT HOLSTER

Molded nylon half holster. Uncovered full barrel, adjustable quick release. Two uses: inclined on the right side or cross-draw.

AVAILABLE FOR

L/Auto - L/Auto Compact - M/Auto - Rev. 2", 3", 4"



series

FR2

THERMO MOLDED CORDURA BELT HOLSTER.

Adjustable lace with front release Polymer Slider/Snap. Double ribbons belt loop for greater comfort on hip.

AVAILABLE FOR

L/Auto - L/Auto Compact - M/Auto



CONCEALMENT > NYLON SHOULDER HOLSTERS

series

A2

CORDURA VERTICAL SHOULDER HOLSTER

Cordura vertical shoulder holster, adjustable quick release. For right and left hand.

AVAILABLE FOR

XL/Auto - L/Auto - L/Auto Compact - M/Auto - S/Auto - Rev 2", 2½", 4", 6", 6½"



series

F02

HORIZONTAL SHOULDER AND BELT HOLSTER

Horizontal shoulder and belt holster. Quick release. Two uses: horizontal on the shoulder or on the belt right side.

AVAILABLE FOR

L/Auto - L/Auto Compact - M/Auto - S/Auto - Rev 2", 2½", 4"



ACCESSORIES COMPATIBLE WITH - A2, F02 HOLSTERS SERIES

cod.
2K03

NYLON SHOULDER KIT
Nylon shoulder kit with double magazine case suitable for F02, A2.



cod.
2K00

NYLON SHOULDER KIT
nylon shoulder kit with single magazine case suitable for F02, A2.

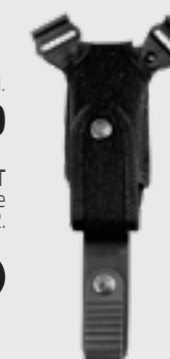



CONCEALMENT > NYLON SHOULDER HOLSTERS

series OS2

NYLON SHOULDER HOLSTER

Cordura molded holster with level 3 safety grade, double magazines cases. Holster can be removed from the Shoulder Harness and worn on the belt using the back polymer belt loop. Also available with Rubber Shoulder harness item OSR2.

AVAILABLE FOR
Beretta 92/98 -Taurus PT92 -Glock 17/18/19/22/23/26/27/31/32/45/47 -H&K VP9/SFP9, P30, USP Comp, P2000 -Sig Sauer P2022 -Walther P99Q,PPQ



series LO2

CORDURA HORIZONTAL SHOULDER HOLSTER

For pistol with or without flashlight or/and laser, modular ribbons system to attach other accessories, double safety closure, removable belt strap for a better stability, double magazines cases, rotative buckles for shoulder system.

AVAILABLE FOR L/Auto - L/Auto Compact



series SAM2

MODULAR NYLON SHOULDER RING

Shoulder strap with velcro adjustment size, 3D padded fabric with high breathability, adjustable straps with rotating buckles. On one side horizontal holster with adjustable thumb snap and safety Velcro lace. On the other side triple magazine cases with adjustable flap closure.

AVAILABLE FOR
L/Auto - L/Auto Compact



CONCEALMENT > POLYMER SHOULDER HOLSTERS

series CCXS8 "CAMA X SHOULDER"

INJECTION MOLDED POLYMER SHOULDER HOLSTER

Retention screw. Safety catch on trigger guard with thumb release. Underarm kit in soft polymeric material, ventilation system, double modular support for the insertion of multiple accessories both by means of a toothed wheel and by means of a screw system. Double magazine case in polymer with adjustable and removable flap included. It can be mounted on all Vega Holster loops and kits. Possibility of inserting R.S.A. "Rotating System Accessories".

AVAILABLE FOR
-Glock 17/18/19/22/23/31/32/45/47 -Sig Sauer P320 Full Size/ Compact/M17/M18



series CCHS8 "CAMA SHOULDER"

PROFESSIONAL POLYMER INJECTION MOLDED SHOULDER HOLSTER SYSTEM

Injection rubber shoulder harness, double platforms with rotative and multi holes system. Double injection molding magazine cases with movable and adjustable flap closure. Holster Retention level II. Retention screws and clip with double friction points. Index finger release of the front safety lock. Possibility of closing the bottom opening. Possibility of fully covered index finger safety lever. Possibility of inserting front protection for greater weapon safety. Loop opening with safety mechanism. International patent. The two platforms are compatible with all Rotative system Accessories (it is possible to introduce different combination as Magazine case and Baton case, Baton Case and Light case, Light case and Magazine case).

AVAILABLE FOR
-Glock 17/18/19/22/23/31/32/45/47 - Beretta APX, 92/98/A1 -H&K P30/P30L/30SK - H&K VP9/SFP9/SUB COMPACT



series SHWS8 "SHOCKWAVE SHOULDER"

SHOCKWAVE SHOULDER VERSION

injection molded holster with automatic trigger guard safety mechanism. Injection strong-rubber Shoulder harness with adjustable VAS buckle system. Injection double magazines cases with adjustable angle. Available for the same Shockwave Concealment Pistols.

AVAILABLE FOR
Beretta 92/96/98 -Glock 17/19/22/23/31/32/37/38/45/47 -H&K USP Standard, USP Compact -Sig Sauer 2022





CONCEALMENT > LEATHER SHOULDER HOLSTERS

series
OS1

SAFETY SHOULDER HOLSTER

Leather molded holster with level 2 safety system.
Double magazine cases with snaps closure flaps cover.
Holster can be removed from the shoulder harness and worn on the belt using the belt loops on the back.

AVAILABLE FOR
Beretta 92/98-Taurus PT92 -Glock 17/18/19/22/23/26/27/31/32/45/47 -H&K VP9/SFP9, USP Comp, P2000 -Sig Sauer P2022 -Walther P99,PPQ



series
OK1

SHOULDER OR BELT HOLSTER

Horizontal shoulder or belt leather holster. Safety quick release. Four positions: horizontal on the shoulder, on the belt on the right side, cross draw or horizontal on the back. Double magazine case.

AVAILABLE FOR
Beretta APX, 92/98, 84, 8000, 9000, PX4, 90TWO -Browning High Power -Colt Government -Glock 17/19/20/21/22/23/26/27/30/31/42/43/45/47 -H&K VP9/SFP9, USP, USP Compact, P2000, P30 -Sig Sauer P220, 226, 228, 229, 230, 320, 2340, 2009, 2022 -S&W M&P M2.0 -S&W Auto 3 1/2" 4", 1911's -Springfield 1911's, XD -Tanfoglio GT21, Force, Police, Pro -Taurus PT92, 24/7, 1911's -Walther P99, PPK, PPS -CZ SP01



VEGAHOLSTER.COM

CONCEALMENT > LEATHER SHOULDER HOLSTERS



series
O1 "AUTO"

SHOULDER OR BELT LEATHER HOLSTER

Horizontal Shoulder or belt leather holster, quick release. Four positions: horizontal on the shoulder, on the belt on the right side, cross draw or horizontal on the back.

AVAILABLE FOR
Beretta APX, 92/98, 84, 8000, 9000, PX4, 90TWO -Browning High Power -Colt Government -Glock 17/19/20/21/22/23/26/27/30/31/32/42/43/45/47 -H&K VP9/SFP9, USP, USP Compact, P2000, P30 -Ruger SP101 2 1/2" -Sig Sauer P220, 226, 228, 229, 230, 320, 2340, 2009, 2022 -S&W M&P M2.0 -S&W Auto 3 1/2" 4", 1911's -Springfield 1911's, XD -Tanfoglio GT21, Force, Police, Pro -Taurus PT92, 24/7, 1911's -Walther P99, PPK, PPS -CZ SP01



series
O1REV

SHOULDER OR BELT LEATHER HOLSTER

Horizontal Shoulder or belt leather holster, quick release. Two positions: horizontal on the shoulder or on the belt on the right side.

AVAILABLE FOR
Rev. 2" 2 1/2" 4"



cod.
1K00

SHOULDER KIT WITH SINGLE MAGAZINE CASE SUITABLE
For series: O1, AE1, AA1.



cod.
1K03

SHOULDER KIT WITH DOUBLE MAGAZINE CASE SUITABLE
Suitable for series: O1, AE1, AA1.



cod.
1K06

SHOULDER KIT WITH DOUBLE SPEEDLOADER CASE SUITABLE
For series: O1, AE1, AA, DA1.



cod.
1K01

SUEDE SHOULDER KIT
Suitable for series: O1, O1 Rev., AE1, AA1, DA1.



cod.
1K02

SHOULDER KIT LEATHER LOOP
Leather loop for attachment to the belt for series: O1.



VEGAHOLSTER.COM



CONCEALMENT > LEATHER SHOULDER HOLSTERS



series **AE1**

VERTICAL SHOULDER HOLSTER
Vertical lined leather shoulder holster, adjustable quick release.

AVAILABLE FOR
L/Auto - L/Auto Compact - M/Auto - Rev. 2½" 4"



series **AA1**

VERTICAL SHOULDER HOLSTER
Vertical molded leather shoulder holster, adjustable quick release.

AVAILABLE FOR
L/Auto - L/Auto Compact - M/Auto - Rev. 2½" 4" 6" 6½"



CONCEALMENT > LEATHER SHOULDER HOLSTERS



series **A1**

VERTICAL SHOULDER AND BELT HOLSTER
Multipurpose shoulder and belt lined leather holster, quick release. Five uses: vertical on the shoulder, on the belt inside or outside.

AVAILABLE FOR
L/Auto cod. A100 - M/Auto cod. A101



series **GA1**

ROTATIVE SHOULDER AND BELT HOLSTER
Multipurpose rotative shoulder and belt leather holster, quick release. Five uses: vertical rotative on the shoulder, on the belt inside or outside.

AVAILABLE FOR
L/Auto cod. GA112 - M/Auto cod. GA113



series **DA1**

UPSIDE DOWN VERTICAL LEATHER SHOULDER HOLSTER
Upside down vertical leather shoulder holster. Elastic retention.

AVAILABLE FOR
Colt Detective, Python 2½", 4" - Ruger SP101 2½" - S&W rev J Frame 2", K Frame 2½" 4", L Frame 4" - Taurus rev 2"



series **OA1**

HORIZONTAL SHOULDER AND BELT HOLSTER
Multipurpose horizontal shoulder and belt leather holster, quick release. 3 uses: horizontal on the shoulder, on the belt inside or outside.

AVAILABLE FOR
L/Auto cod. OA110



series
CC1

ANKLE HOLSTER IN LEATHER AND ELASTIC
Below the knee elastic retention with velcro adjustment. Adjustable safety lace. Elastic system for easily accommodating different types of weapons. Ankle fastening system that can be adjusted and closed with velcro.

AVAILABLE FOR
S/Auto - M/Auto - Baby Auto - Rev. 2", 2½"

series
C1

LEATHER ANKLE HOLSTER
Leather ankle holster. Quick release. Adjustable under the knee with a velcro strap support. Padded suede ankle strap.

AVAILABLE FOR
Beretta 81, 84 - Colt Detective - Ruger SP101 2¼"
- S&W Rev. J Frame 2" - K Frame 2½" - Sig Sauer 230 - Taurus Rev. 2" - Walther PPK

series
CB1

LEATHER ANKLE HOLSTER
Leather ankle holster. Velcro release. Padded suede ankle strap. Elastic retention.

AVAILABLE FOR
S/Auto - M/Auto - Baby Auto - Rev. 2", 2½"

series
CA1

UPSIDE DOWN LEATHER ANKLE HOLSTER
Upside down leather ankle holster, padded suede ankle strap, elastic retention.

AVAILABLE FOR
M/Auto - S/Auto - Rev. 2", 2½"

series
C2

NYLON ANKLE HOLSTER
Nylon ankle holster, quick release, adjustable under the knee with a velcro strap support, padded ankle strap.

AVAILABLE FOR
M/Auto - S/Auto - Rev. 2", 2½"

cod.
2ET01

ELASTIC BELLY BAND
Elastic belly band, pistol holster, handcuffs case, double magazine case. General pocket with zip.

Sizes: I/II
Available for:
M/Auto, L/Auto Compact, L/Auto

cod.
2ET20

MULTI POCKET ELASTIC BELLY BAND
To carry handgun, expandable baton, mobile phone, magazines, knife and other accessories. In reinforced, light colour elastic, velcro adjustment.

Sizes: I/II
Available for:
M/Auto, L/Auto Compact, L/Auto

cod.
2ET21

ELASTIC BELLY BAND
Multi-pockets for carrying multiple accessories. Elastic short weapon holster for accommodating different types of weapons.

Sizes: S/M/L/XL
Available for:
M/Auto, L/Auto Compact, L/Auto

cod.
2ET22

BELT IN DOUBLE REINFORCED
Webbing with passages (right hip and left hip) for inserting and carrying short weapons. Injection molded plastic buckle.

Sizes: S/M/L/XL
Available for:
M/Auto, L/Auto Compact, L/Auto

cod.
2U92

BELT HANDGUN POUCH IN NYLON
Compact shape with 4 belt holes for vertical or horizontal use. Multipurpose outer pocket. Pocket for weapon with zip fastening with adjustable elastic holster and magazine case.

AVAILABLE FOR
M/Auto, L/Auto Compact



CONCEALMENT > FANNY PACKS

cod.
2U93

WAIST FANNY PACK
Nylon compact waist fanny pack with inside holster.
Double front outside zip closure pockets.
Double sides small pockets.
Quick access pistol compartment with adjustable velcro holster.
Adjustable nylon belt.

AVAILABLE FOR
M/Auto, L/Auto Compact, L/Auto



cod.
2U90/91

CORDURA WAIST PACK WITH HOLSTER
Cordura waist pack with elastic holster and elastic magazine case, quick access to the Pistol, 4 compartments, adjustable nylon belt.

AVAILABLE FOR
L/Auto cod. 2U90 - L/Auto Compact cod. 2U90 - M/Auto
cod. 2U90 - Rev. 2 1/2", 3", 4" cod. 2U91



cod.
2U99

NYLON WAIST PACK WITH HOLSTER
Nylon waist pack with elastic holster and elastic magazine case.
Quick access to the pistol, 4 compartments, adjustable nylon belt.

AVAILABLE FOR
M/Auto, L/Auto Compact, L/Auto



cod.
2U80

NYLON SINGLE SHOULDER STRAP RUCKSACK
Nylon single shoulder strap rucksack suitable for pistol concealment.
Double fastening system.
Fast access pocket with holster for pistol and magazine/knife/lights holder,
mobile phone pocket, 2 multipurpose pockets, velcro badge holder.

AVAILABLE FOR
M/Auto, L/Auto Compact, L/Auto

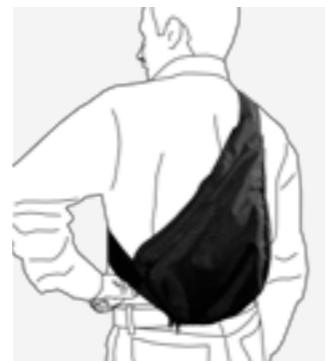

CONCEALMENT > BAGS COLLECTION



LOCKABLE ZIP PULLER

CONCEALMENT HOLSTER POCKET



cod.
1VB010 "ACROSS CITY V.B."
MEDIUM CAPACITY PURSE IN EXTRA COTTON AND LEATHER
The Vega classic all days medium capacity purse in new casual gray extra cotton and black leather and with a new long version shoulder strap.
Sides pockets with VH lockable zip puller system.
Inside velcro modular wall for holsters and magazines cases.



cod.
1VB011 "SIMPLY TRAVEL V.B."

ONE SHOULDER STRAP SMALL PURSE IN EXTRA COTTON AND LEATHER
Casual extra cotton gray/black material.
Easy line with an outside zip closure pocket and main compartment
with VH lockable zip puller system.
Inside velcro modular wall for holsters
and magazines cases concealment carry.



cod.
1VB013 "V. WRISTLET V.B."

WRISTLET POUCH IN EXTRA COTTON AND LEATHER
Wristlet in casual gray extra cotton and black leather.
One leather wrist lace.
Good for use inside of all bags.
Sides pockets with VH lockable zip puller system.
Inside velcro modular wall for holsters and magazines cases concealment carry.

DUTY
TACTICAL
CONCEALMENT
SPORT
GLOVES
+

GUIDE



LOCKABLE ZIP PULLER

CONCEALMENT HOLSTER POCKET



cod. **1VB009** "TOUR V.B."

LARGE MULTI USES DUFFLE BAG
Main compartment with inside pocket and zip closure.
Front outside large pocket with locked holes closure (padlock included)
Inside velcro modular wall for machine guns attachments laces (included).
Handguns holster.
Magazine cases.
Double strong reinforced handles and movable shoulder strap. attachments laces (included).
Handguns holster.
Magazine cases.
Double strong reinforced handles and movable shoulder strap.



1VB009 front modular compartment, configuration examples



cod. **1VB001** "CITY V.B."

WOMEN LEATHER BAG
Classic all days medium capacity purse with double sides zip.
Inside velcro modular wall for holsters and magazine cases.



cod. **1VB003** "EXPLORER V.B."

CLASSIC MEN AND WOMEN FUNNY PACK
Double zip aperture.
Multy pockets.
Inside velcro modular wall for holsters and magazine cases.



cod. **1VB002** "TRAVEL V.B."

CLASSIC MAN OR WOMEN ONE SHOULDER STRAP PURSE
Inside velcro modular.



cod. **1VB005** "BUSINESS V.B."

BUSINESS BAG MEDIUM SIZE
Multipockets.
Back compartment with inside velcro modular wall for holsters and magazine cases.



cod. **1VB004** "SPORTY V.B."

ONE SHOULDER LEATHER RUCKSACK
Medium main compartment
Back compartment with inside velcro modular wall for holsters and magazine cases.



cod. **1VB008** "ROAD V.B."

DOUBLE SHOULDER STRAPS RUCKSACK
Medium main compartment.
Back discrete compartment with locked holes closure (padlock included).
Inside velcro modular wall for holster (included) and magazine cases attachment.
Top and side handling.
Front outside pocket with zip closure.

DUTY **D**

TACTICAL **T**

CONCEALMENT **C**

SPORT **S**

GLOVES **G**

+

GUIDE

GUIDE

SPORT > EYEWEAR



166 LEATHER BELTS

167 WESTERN RIGS

168 SHOOTING KIT

169 APPAREAL

170/171 VEGA HOLSTER EYEWEAR



SPORT > LEATHER BELTS

cod.
1C00

LEATHER BELT WITH SOLID BRASS BUCKLE
Without stitching.
H cm 4
Sizes: S/M/L/XL



cod.
1C01

LEATHER BELT WITH SOLID BRASS BUCKLE
Without stitching.
H cm 3
Sizes: S/M/L/XL



cod.
1C20

LEATHER BELT WITH SOLID BRASS BUCKLE
Central stitching.
H cm 4
Taglie/Sizes: S/M/L/XL



cod.
1C10

LEATHER BELT WITH SOLID BRASS BUCKLE
Lateral stitching.
H cm 4
Sizes: S/M/L/XL



SPORT > WESTERN RIGS



cod.
CW100

WESTERN HOLSTER
Western holster in treated tan leather with basket finish and script.
Available for: Single Action 6½"



cod.
CW110

WESTERN CROSSDRAW HOLSTER
In treated tan leather with basket finish and script.
Available for: Single Action 6½"



cod.
1CW51

WESTERN RIG IN TREATED TAN LEATHER
Central bullet loops and solid brass buckle.
Sizes: S/M/L/XL



serie
1CA

WESTERN RIG IN TREATED TAN LEATHER
With central bullet loops, brass buckle and thermo-moulded holster.
Lace to fix on the leg.
Trigger safety catch.
Firearm grip below the belt.
Sizes: S/M/L/XL



AVAILABLE FOR
Revolver 6" 38/357: cod. 1CA50
Revolver 6½" cal. 44: cod. 1CA51
Single action 6½": cod. 1CA52

DUTY

TACTICAL

CONCEALMENT

SPORT

GLOVES

+

GUIDE



SPORT > SHOOTING KIT

series **VKOS8** "SPORT"

POLYMER HOLSTER OPEN ON THE FRONT, COMPATIBLE WITH RDO

Designed for those who want a very fast holster positioned below the belt line.
Increased thickness polymer.
Double retention screw acts on the trigger guard and the barrel.
Seal forming on the trigger guard.
Sport loop with grip of the weapon below the belt line, which allows adjustment at 3 different heights (by means of screws), adjustment of the tilt -10°, 0°, +10° (by means of screws), adjustment of the retention on the belt by means of the 4 fixing screws and the distance of the holster from the body by insertion through 1 or 2 spacers.
Vegatek thermoforming.

AVAILABLE FOR:
Beretta APX, 92, 96, 98, PX4 -Colt 1911 e simili/1911's (and clones) -Glock 17/19/22/23/31/32/37/38/45/47 -H&K SFP9, VP9/SFP9, USP Standard, USP Compact, P30 -Sig Sauer 226, 320, 2022 -Walther P99 last edition -CZ SP01 -Springfield XDM -Tanfoglio Gold Match/Limited Custom/Stock 2/Stock 3P/Custom P/Force NG

SAFETY GRADE 1



cod. **2V55**

DYNAMIC SHOOTING NYLON BELT

With inside polymer lined, backed with velcro to attach to the under belt.
Safety catch and nine holes for exact fit closure. Rigid tape under belt including:
Sizes: I, II, III, IV, V, VI, VII, VIII



cod. **8TP00**

DYNAMIC SHOOTING MAGAZINE HOLDER

In acetalic resin for professional use, rotating 360° for any angle use, adjustment retention screws, can be used on the back or on the side positions, adjustable belt retention, interchangeable washers provided for use with all types of pistol magazine.



cod. **2B20**

37x19 cm

cod. **2B21**

37x28 cm

cod. **2B22**

50x34 cm



RECTANGULAR NYLON PADDED PISTOL RUG
One zip pocket.

cod. **2B10**

18x32 cm

cod. **2B11**

15x27 cm

cod. **2B12**

13x20 cm



NYLON LIGHT PADDED PISTOL RUG

cod. **2B00**

45x25x28 cm

NYLON LARGE UTILITY BAG
Outside pocket with magazine holders, central large compartments, upper padded pocket, amovable padded pistol cases.
Adjustable shoulder strap. Nylon transport handles.



VEGAHOLSTER.COM

SPORT > APPAREAL

cod. **VW08**

CAP WITH EMBROIDERED VEGA HOLSTER logo. One size fits all.



cod. **VW09**

BEANIE WITH VEGA HOLSTER LABEL LOGO
One size fits all.



cod. **MG04**

VH SOFT-SHELL JACKET WITH HOOD AND ZIP.
Appliques rubberized logos

● Sizes: M/ L/ XL



cod. **MG02**

VH SWEATSHIRT WITH HOOD AND FRONT ZIP.
Embroidered VH logo

● Sizes: M/ L/ XL



cod. **MG03**

VH COTTON PIQUET POLO SHIRT.
Embroidered VH log
Sizes: in M/ L/ XL



cod. **MG00**

LONG SLEEVED COTTON T-SHIRT
Sizes: S, M, L, XL



cod. **MG01**

VH ROUND LOGO COTTON T-SHIRT
Sizes: S, M, L, XL

VEGAHOLSTER.COM





VEW

VEGA eyewear



AIR SYSTEM

cod.
VEW01 "RAM"

Ram is a goggle final result of a collaboration between Vega Holster, optic specialist and military/law enforcement departments. The target it was to arrive at a goggle with superior performance and quality. Injection molding frame with superior material, conform to all normative ANSI/ZE A Z87.1/2010, il MIL-DTL-43511D and the STANAG2920 V50= 223 m/s. The "RAM" lenses have a specific anti-scratch and anti-fog treatment. The elastic band have a double adjustment buckle and a silicon stripe for a better grip on the helmet. The lens are available in 3 different colors: white, gray for sun condition, yellow for fog/dark conditions. RAM is available in 3 different colors: black, OD green, desert-coyote. It is possible to insert a nose guard (optional item VEW99).

AVAILABLE COLOURS



AVAILABLE LENS COLOURS



cod.
VEW99

OPTIONAL Nose guard

CONFORM TO THE STANDARD
ANSI/ZE A Z87.1/2010
MIL-DTL-43511D
STANAG2920 V50= 223 m/s



SPORT > **VEGA HOLSTER EYEWEAR**



cod.
VEW02 "TEMPEST"

INCLUDED

The Multi uses TEMPEST eyewear born for Military and Law Enforcement uses, meet the standard ANSI Z87.1+ and EN166. Polymer frame with double Carry options: By standard temples (arms) or By Elastic head strap. Movable frame with foam at protection from Wind, Dust or Sand. 2mm Polycarbonate resistant lenses. 3 different colors lenses : White, Gray and Desert-Coyote INCLUDED.

AVAILABLE LENS COLOURS



AVAILABLE COLOURS



cod.
"LEGEND" **VEW05**

Born for military, law enforcement and sport uses. Meet the standard ANSI Z87.1+ and EN166. Polymer frame with double carry options: by standard temples (arms) or by Elastic head strap. 2mm Polycarbonate resistant lenses. 3 Different colors lenses : White, Gray and Desert-Coyote INCLUDED. Including the double function Microfiber pocket.



INCLUDED

AVAILABLE LENS COLOURS



cod.
"GLORY" **VEW06**

The Multi uses GLORY eyewear born for Military, Law Enforcement and Sport uses. Meet the standard ANSI Z87.1+ and EN166. Polymer frame with adjustable length temples (arms). 2mm Polycarbonate resistant lenses. 3 Different colors lenses : White, Gray and Desert-Coyote INCLUDED. Including Neoprene Neck lace and the double function Microfiber pocket.



INCLUDED

AVAILABLE LENS COLOURS





VEGA GLOVES FEATURES

ANTI CUT LINING

Many models for Duty and Law Enforcement uses have a CUT RESISTANCE inside lining with different protections levels. Vega holster use for their Gloves the most innovative and high performance material/fabrics as Dynema, Spectra, Kevlar Shark Skin and sign the protection level with a scale that goes from a medium Level to a Level 5, the maximum on the normative EN388. All gloves with anti-cut lining have more or less cut resistance degree but any of them can guarantee a 100% protection.



Medium cut resistance



Good cut resistance.



Optimal cut resistance at level 5 according on European Regulation CEEN388



Puncture and needles high resistance inside lining.

TOF System (Turn on the Fingers)

It is a special construction of the glove that turns around the final part of the fingers and ends with the junction on the dorsal part of the same; such system favors sensitivity and attenuates the annoyance that standard construction can give in this point.

OSH (Molding on the shape hand)

When the hand is in its natural position it does not have a straight shape but is slightly bent towards the closing, such a molding does not force the position of the hand because it accommodates the natural position, moreover it facilitates the grip of arms, instruments, objects etc.

Neoprene Wrist with VH rubber lace

The construction of the inferior part of the glove in this material gives greater protection to the external part of the wrist (that is mainly subject to hits), the one which it gives greater adhesion and stability thanks to its elastic characteristic and to the use of the adjustment by velcro through the lace in printed and injected rubber, compatible with wrist-compass or wrist-thermometer or other similar accessories that have 3 / 4 " watchband passage.

Knuckles protection

During a Police and/or Military operation, the part of the hand that is mainly submitted to contact with walls, ground, blunt objects would be the knuckles of the fingers and of the hand, in this point VH has inserted Polymer or leather or padded leather protection along the destination of use varying on the model of glove.

RING for coupling to port system

This special ring, besides, has the function of coupling for the transport through a shackle on a belt or backpack, it is also useful, thanks to its wide anti-slide surface, to facilitate the placement of a glove when one of the two is already worn.

SIZING GUIDE

Use this method to find your approximate glove size.



SIZING CHART (see pag. 190)

MEASUREMENT	GLOVE SIZE
20 cm (8")	Small
23 cm (9")	Medium
25 cm (10")	Large
28 cm (11")	X-Large

GLOVES > TACTICAL AND MILITARY USES

cod.

OG65 "IMPACT-PRO"

OPERATIONAL TACTICAL GLOVES IN KEVLAR

Knuckle protection system "A.K.P.S".
Patented for protection against impacts and best performance for internal comfort.
Reinforced leather palm with padded patch on the areas subject to gripping weapons/objects and patch on index finger compatible with touch screen use on mobiles and tablets; adjustable Velcro closing strap on the wrist.
Reinforced padding to protect the knuckles on the fingers and the lower part of the back.
Kevlar fiber for greater protection from exposure to heat and sharp objects

Sizes: S, M, L, XL, XXL



A.K.P.S. TECHNOLOGY
For superior impact protection & inner comfort.
International Patent Pending



cod.

OG66 "CENTURION"

OPERATIONAL TACTICAL GLOVES IN MULTI MATERIAL

Complete protection on the back in RUBBERTEK directly fixed onto glove without seams; flexing areas especially studied for greater comfort and dexterity.
Reinforced suede palm with padded patch on the areas subject to gripping weapons/objects, special spreading on index finger and thumb compatible with touch screen use on mobiles and tablets; adjustable velcro closing strap on the wrist.
Reinforced outer index finger padded and anti-slip for handling weapon.

Sizes: S, M, L, XL, XXL



VEGAHOLSTER.COM

DUTY D

TACTICAL T

CONCEALMENT C

SPORT S

GLOVES G

+

GUIDE

cod.
OG58 "FIT-PRO"

LEATHER AND SYNTHETIC TACTICAL GLOVE
External elastic fabric with special rubber protection insert.
Slip leather on the palm with padded parts on the stress points.
Adjustable rubber wrist lace.
Maximum sensibility.

Sizes: S, M, L, XL.



cod. **OG47** "MONSTER" cod. **OG48** "MONSTER WINTER"

PROFESSIONAL-OPERATIVE GLOVE
First quality suede leather with double reinforce on the palm.
Spandex on the back for a better movements.
Injection rubber reinforce on the knuckles, suede leather reinforce on the fingers final parts.
Rubber adjustment lace on the wrist. Neoprene wrist protection.
MONSTER WINTER with thinsulate and pile inside lining.

Sizes: S, M, L, XL.



cod.
OG21 "TESTUDO MISSION"

PROFESSIONAL GLOVE FOR POLICE, SPECIAL FORCES, MILITARY USES

Chamude synthetic leather palm with double reinforce. 3D knit space fabric and spandex on the back. Hard Polymer protection on the knuckles of the fingers. Hard Polymer protection on the knuckles. Seams with an exorbitant amount of resistance to wear and tear. The index and Thumb fingers imprinted with anti-slide stripes of silicon rubber for greater adhesion on the arm or seized object. Terry Cloth on the back of the thumb. Cuff in Neoprene for greater adhesion and protection.
VH Lace with velcro on the wrist. Ring for coupling to port system.

Sizes: S, M, L, XL, XXL.



cod.
OG45 "ALPHA"

PROFESSIONAL-OPERATIVE GLOVE

First quality leather with double reinforce on the palm.
Neoprene on the back for a better protection from wind, cold temperature and humidity.
Rigid Reinforce on the Knuckles, in two parts for a better movement.
Padded reinforce on the Fingers Knuckles for a better protection.
Leather reinforce on the fingers final parts. Rubber adjustment lace on the wrist.
Neoprene wrist protection.

Sizes: S, M, L, XL.



cod.
OG14 "MOTO CC"

LIGHT GLOVES

In transpiring fabric on top for greater aeration and chamois leather on the palm for greater grip. Knuckle protection with a polymer insert.
High visibility insert, "Police" written (personalized upon request of quantity) on the rubber closing lace with velcro adjustment.

Sizes: S, M, L, XL.



cod.
OG55 "THE MEC"

MULTIPURPOSE GLOVES

In stretch fabric on top. Chamois leather on the palm for greater protection and greater grip. Reinforced with chamois leather on areas prone to greater wear. Rubber lace with Velcro adjustment. Nylon lace for attachment to snap-hooks.

Sizes: S, M, L, XL



cod.
OG41 "COP OVER 5"

ALL USE GLOVE MADE IN SPANDEX, NEOPRENE AND LEATHER

All Use Gloves made in Spandex and Neoprene for knuckles protection on the back and leather on the palm.
No Cut Armortex inside lining that answer to the CE EN 388 Normative with maximum grade of resistance Level 5, ideal for military, law enforcement and search.
Special VH rubber lace for adjustable velcro closure.

Sizes: S, M, L, XL, XXL



cod.
OG71 "JOLLY"

MULTIPURPOSE GLOVE

Padding on the palm for greater comfort in case of prolonged use.
Non-slip silicone inserts for improved grip in any weather situation.
Elastic and neoprene on the back for better adaptability.
Adjustable Velcro closure on the wrist.

Sizes S, M, L, XL, XXL



cod.
OG46 "ESSENCE"

PROFESSIONAL-OPERATIVE GLOVE

First quality leather with double reinforce on the palm.
Neoprene on the back for a better protection from wind, cold temperature and humidity.
Leather reinforce on the fingers final parts.
Rubber adjustment lace on the wrist.
Neoprene wrist protection.

Sizes: S, M, L, XL





GLOVES > TACTICAL AND MILITARY USES



cod. **OG51** "DELTA-L"

TACTICAL GLOVE IN KEVLAR LONG CUFF

Leather reinforcements on back with padding on knuckles, elastic at wrist and end of glove. Leather palm with double reinforcement in areas of most wear and weapon grip areas. Tip of index finger and thumb with special touch screen treatment. Side PATCH in rubber with NON SLIP TANK SYSTEM for resting when pointing. The increased thickness kevlar fabric makes these gloves particularly resistant to abrasion and wear.

Sizes: S, M, L, XL



cod. **OG22** "TESTUDO COMBAT"

PROFESSIONAL GLOVE FOR POLICE, SPECIAL FORCES, MILITARY USE

First quality goat skin with special woven anti-wear treatment. Nomex + kevlar mix for high resistance to heat and abrasion. Hard polymer protection on the knuckles. Forearm External Padded Protection. Seams with an exorbitant amount of resistance to wear and tear. Large adjustment leather band with velcro closure on the wrist. Ring for coupling to port system.

Sizes: M, L, XL, XXL



cod. **OG50** "DELTA-S"

TACTICAL GLOVE IN KEVLAR SHORT

Leather reinforcements on back with padding on knuckles, wrist adjustment lace. Leather palm with double reinforcement in areas of most wear and weapon grip areas. Tip of index finger and thumb with special touch screen treatment. Side PATCH in rubber with NON SLIP TANK SYSTEM for resting when pointing. The increased thickness kevlar fabric makes these gloves particularly resistant to abrasion and wear.

Sizes: S, M, L, XL, XXL



cod. **OG52** "DELTA PRO"

TACTICAL GLOVE IN KEVLAR

Leather reinforcements on back with rigid knuckles protection, wrist adjustment lace. Leather palm with double reinforcement in areas of most wear and weapon grip areas. Tip of index finger and thumb with special touch screen treatment. Side PATCH in rubber with NON SLIP TANK SYSTEM for resting when pointing. The increased thickness kevlar fabric makes these gloves particularly resistant to abrasion and wear.

Sizes: S, M, L, XL



VEGAHOLSTER.COM

GLOVES > TACTICAL AND MILITARY USES



cod. **OG54** "H-ROPE"

GLOVES FOR FAST ROPE

Use, extra thick leather on the palm and areas prone to greater wear when used on rope. Extra thick leather on the palm for a greater grip. The reinforcement stretches from the palm down to the lower part of the fingers. Double inner lining, a mid lining in Kevlar and an internal lining in soft fabric for greater comfort. Hole with a rubber ring for quick attachment to snap-hooks. Flared opening for easy fit.

Sizes: S, M, L, XL



cod. **OG15** "ACTION"

Spandex and Leather Glove
Sizes: S, M, L, XL sizes.

cod. **OG16** "ACTION PLUS"

Cut resistance Kevlar lining:
Sizes: S, M, L, XL, XXL sizes

Ideal for military, law enforcement and no riot uses. Thermo molded padded on the wearing points, leather on the palm with padded reinforces, little holes on the sides fingers for air ventilations, special rubber lace for adjustable velcro closure.



cod. **OG05** "ARMOUR"

OPERATIVE LEATHER GLOVE

Operative Leather Glove with anatomic padded on the Back and on the fingers, adjustable velcro closure, design for operative mission, riots or hardcore assaults where is request an extreme protective and resistant glove. Elastic retention.

Sizes: S, M, L, XL, XXL sizes.



cod. **OG06** "HALF ARMOUR"

OPERATIVE HALF FINGERS LEATHER GLOVE

Operative Half Fingers Leather Glove with anatomic padded on the back and on the fingers, adjustable velcro closure, design for operative mission, riots or hardcore assaults where is request an extreme protective and resistant glove. Elastic retention.

Sizes: S, M, L, XL, XXL sizes.



VEGAHOLSTER.COM



cod. **OG49** "CITY FIGHTER LEVEL 5"

LEATHER GLOVE FOR HIGH RISK TACTICAL OPERATIONS

Made entirely of leather with rigid knuckle protector, reinforcements in non-slip material on palm in areas of most wear and where weapon or operating instruments are held. Adjustable wrist lace with velcro, slightly elongated shape for increased cover. Fully lined with Dynema for grade 5 protection according to CE EN 388 standard for cutting by blades and sharp objects.

Sizes: S, M, L, XL, XXL



cod. **OG44** "COP"

OPERATIVE GLOVES IN PADDED LEATHER

Glove suitable for anti-riot operations. Padded leather on the fingers and on the back for a total hand and wrist protection. Reinforced no-slip part on the palm to handle baton and shield. Adjustable velcro closure on the wrist for a better fit. Hook for to fix on packs or bags.

Sizes: S, M, L, XL



cod. **OG56** "EXTRA DUTY"



LEATHER GLOVES

Leather gloves for police and law enforcement. High-quality leather on palm and top. Inner lining in cut-resistant fabric of grade 5 protection level, according to norm CE EN 388. Neoprene cuff for greater protection and better fit. Rubber lace adjustment with velcro closure. Patterned directly on the hand for perfect fit. Hidden rigid polymer protection on knuckles. Available in: black.

Sizes: S, M, L, XL, XXL



cod. **OG38** "CITY GUARD OVER 5"



GLOVE FOR POLICE OR SPECIAL FORCES, IDEAL FOR SEARCH USE

1st quality goat skin. No Cut Armortex inside lining that answer to the CE EN 388 Normative with maximum grade of resistance Level 5. Cuff in Neoprene for greater adhesion and protection. VH Lace with adjustable Velcro on the wrist. 3 ribbed seams to on the back. Seams with an exorbitant amount of resistance to wear and tear. OSH modeled directly on the hand for a perfect form of the hand.

Sizes: S, M, L, XL, XXL



cod. **OG37** "CITY GUARD BARRIER"



GLOVE FOR POLICE OR SPECIAL FORCES, IDEAL FOR SEARCH USE

First quality goat skin. Special Elephant Shark Skin Puncture and needles resistance inside lining. Cuff in neoprene for greater adhesion and protection. VH Lace with adjustable Velcro on the wrist. Three ribbed seams on the back. Seams with an exorbitant amount of resistance to wear and tear. OSH modeled directly on the hand for a perfect form of the hand.

Sizes: S, M, L, XL, XXL



cod. **OG30** "CITY GUARD"

PROFESSIONAL GLOVE FOR POLICE, SPECIAL FORCES, MILITARY USES

First quality leather. Cuff in neoprene for greater adhesion and protection. VH lace with velcro on the wrist. Three ribbed seams on the back. Seams with an exorbitant amount of resistance to wear and tear. OSH modeled directly on the hand for a perfect fit. High sensitivity.

Sizes: M, L, XL





GLOVES > LAW ENFORCEMENT AND UNIFORM USES



cod. **OG09** "DUTY FIVE"



CUT LEVEL FIVE RESISTANCE MULTI-USES LEATHER GLOVES
Police and Military uses, cut resistance inside lining that answer to the CE EN 388 Normative with maximum grade of resistance Level 5. Adjustable elastic on the wrist.

● Sizes: S, M, L, XL, XXL



cod. **OG07** "BARRIER"



THE BARRIER GLOVE
Elastic woven on the back and Leather on the palm and on the fingers with lining in "Elephant Shark Skin" a new special woven with a good cut-resistance and a High puncture-resistance (it is the best performance puncture-resistance woven on the market), ideal for search use. Adjustable Vega plastic Lace on the wrist.

● Sizes: S, M, L, XL, XXL



cod. **OG08** "DUTY PLUS"



INSIDE GOOD CUT RESISTANCE SPECTRA LINED LEATHER GLOVE
Inside good cut resistance. Spectra lined leather glove (double resistance respect a Kevlar lining with the same weight). Elastic retention.

● Sizes: S, M, L, XL, XXL



cod. **OG03** "DUTY"

INSIDE LINED ALL USES LEATHER GLOVE
Inside lined all uses Leather Glove. Elastic retention.

● Sizes: S, M, L, XL, XXL

GLOVES > SHOOTING AND SPORT USES



cod. **OG35** "SENSITIVE"

PROFESSIONAL GLOVE FOR POLICE, SPECIAL FORCES, SHOOTING SPORTS USES
On the palm first quality sheep skin, minimal thickness, anti-slide treatment. On the back Lycra with printing reinforce parts on strategic points. Cuff in Neoprene for greater adhesion and protection. VH lace with adjustable velcro on the wrist. Seams with an exorbitant amount of resistance to wear and tear. Highest sensitivity.

Sizes: S, M, L, XL, XXL



cod. **OG28** "G-GRIP"

SHOOTING GLOVE
Synthetic no slip shooting glove. Extreme fit.

Sizes: S, M, L, XL



cod. **OG04** "NEOPRENE 4X4"

SHOOTING NEOPRENE GLOVE
Leather on the palm for better sensibility and grip. No slip rubber on the pistol grip. Adjustable velcro closure.

Sizes: S, M, L, XL



cod. **OG12** "SHOOTING"

HALF FINGERS LYCRA GLOVE
Half fingers lycra glove with no slip material on the palm. Adjustable velcro closure.

Sizes: S, M, L, XL



cod. **OG70** "BIKE"

MULTI-USE HALF FINGER GLOVES
Padded on the palm for greater comfort during prolonged use; anti-slip silicone inserts for a better grip under all weather conditions. Elastic and Neoprene for greater adaptability. Adjustable velcro closure on the wrist

Sizes: S, M, L, XL, XXL



DUTY	D
TACTICAL	T
CONCEALMENT	C
SPORT	S
GLOVES	G
	+
	GUIDE

+ > VEGA LIGHTS

+ > BATONS

cod. **VL01** "SIRIUS"

Professional Torch Vega Light in Duraluminium.



INCLUDED

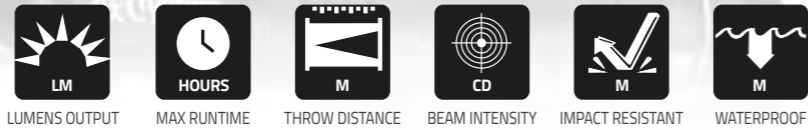

VL01 SIRIUS	0,2÷1000	1950÷1,5	271	18300	1,2	2
--------------------	----------	----------	-----	-------	-----	---

cod. **VL02** "POLARIS"

Professional torch Vega Light in duraluminium.



INCLUDED

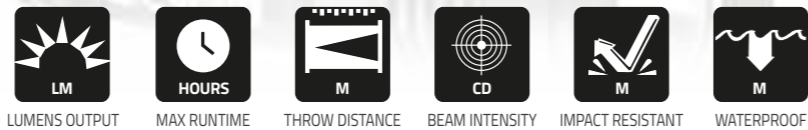

VL02 POLARIS	MAX 600	130	176.1	7760	1,2	2
---------------------	---------	-----	-------	------	-----	---

VEGAHOLSTER.COM

cod. **OE99**

Length: 53 cm



Expandable rigid stick with anatomic rubber handle, nylon pouch included.

cod. **OE92**

Length: 53 cm



cod. **OE93**

Length: 65 cm



Expandable rigid stick with anatomic rubber handle, nylon pouch included.

cod. **OE94**

Length: 42 cm



cod. **OE95**

Length: 57 cm



Expandable springed stick with plastic handle.

cod. **OM40**

Length: 60 cm



Rubber baton, no slip handle. Available: white or black

cod. **OM41**

Length: 58 cm



Polyethylene tonfa baton, rulled handle.

cod. **OM42**

Length: 59 cm open



Alloy expandable tonfa, rulled handle.

VEGAHOLSTER.COM

DUTY **D**

TACTICAL **T**

CONCEALMENT **C**

SPORT **S**

GLOVES **G**

+

GUIDE

+ > LAW ENFORCEMENT ACCESSORIES

+ > SHOOTING ACCESSORIES

cod.
OE50

Special stainless steel handcuffs



cod.
OE60

Stainless steel handcuffs



cod.
OE61

Nickel handcuffs



cod.
OE65

Special Stainless Steel Handcuffs with rigid joint



cod.
OE63

Nylon handcuffs with patented fastening double stop cog.

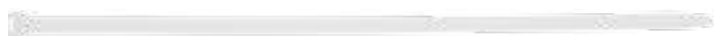

cod.
OE62

Universal handcuffs keys.



cod.
OE83

Anti aggression spray RSG2 for police or security uses, plastic canister holster with safety system, special metal clip. Available colours white, black. Recharge for RSG2 item. OE88.



cod.
OE81

Anti aggression spray OC, 20 ml.



cod.
OE39

Chain for whistle.



cod.
OE37

Large whistle.



cod.
OE38

Small whistle.



cod.
OE90

Peltor hearing protector shotgunner model, folding model. Att. Med. a 500 HZ dB 26.4. Colours: Black, Green, Red



cod.
OE00

Special cleaning cloth



cod.
OE85

Soft ear plugs. SNR 36.

cod.
OE80

Gun oil.



cod.
OE51 OE51 -> CAL 9

cod.
OE52 OE52 -> CAL 7,65
Cleaning pistol set.





SALES DETAILS

- All Vega Holster products are sold "as they are" and "without defects".
- Returned goods will not be accepted unless previously agreed to the company.
- Customer is responsible for shipping charges unless previously differently agreed.
- Merchandise will be travel at buyer's risk.
- No objections will be accepted after 8 days from the receiving of the goods: any objections will not ensure the right to obtain a compensation.
- Payment will be done as the order agreement.
- Vega Holsters reserves the right to make any modifications to the products which it believes improve them or for commercial or technical reasons without giving any warning to the customers warning to the customers.
- This catalogue is the most complete guide to Vega Holster products at today.
- There is no warranty about colours, sizes, dimensions correspondance.
- For any informations please refers to Vega Holster commercial office.

ORDERING INFORMATION

- To fill right the order it's necessary to insert:**
- item code with descriptions (for holster see the fit chart table)
 - Color
 - Right or left hand
 - For holsters specific name and model of the gun, caliber, size of the barrel (to be measure as indicated)
 - For belts specific size (must be measured as indicated)
 - For gloves specific size (must be measured as indicated)

HOLSTERS SIZES GUIDE



BELT SIZES



LEATHER BELTS

	Small	Medium	Large	X/Large
Middle hole	84	96	108	120
Total	103	115	127	140
Minimum to maximum	76-91	89 -103	101-115	113-127

NYLON BELTS (EXCEPT UNDER LIST)

	I	II	III
minimum	80	100	110
maximum	105	125	135

PRATICAL SHOOTING BELTS SIZES

	I	II	III	IV	V	VI	VII
Middle hole of 9	80	86	92	98	104	110	116

Attention for the 2V31/2V56/2V32/2V40/2V41/2V42/2V45/2V46/2V47/2V66/2V67/2V48/2V49/2V52/2V54/2V61/2V63/2V64/2V65 as referement you use the "Leather belt sizes".

GLOVES SIZES

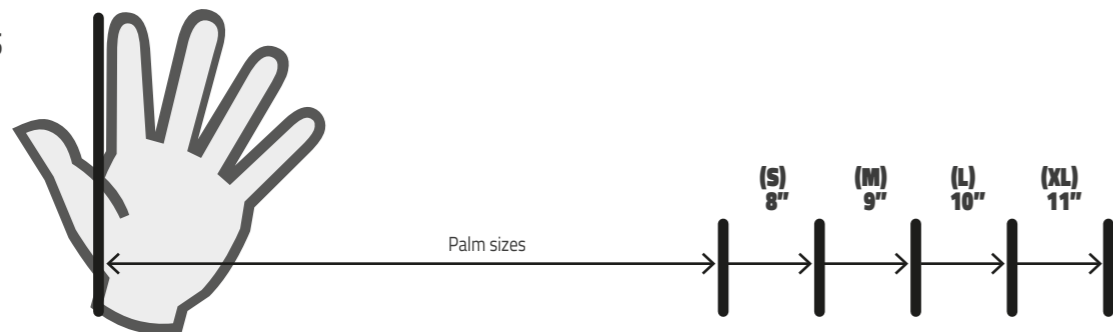

MATERIALS AND COLORS

LEATHER

Vega uses only first quality real leather, tanned using vegetable extracts, completely treated in Italy according to the recent international agreements. Leather means from always exclusiveness and value.



CORDURA - 100% NYLON

Vega uses only original cordura by Dupont; the original cordura Dupont is a highly technological fabric designed to ensure maximum wear and resistance, long life and lightness, particularly suitable in any situation and field.

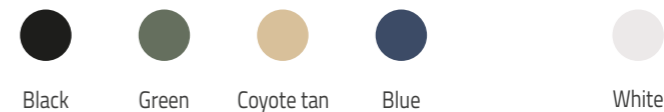

POLYMER

The Vega Holster polymer is a plastic material, wear and impact high resistance, thermo molding or injection molding, suitable in any situation the most difficult too.

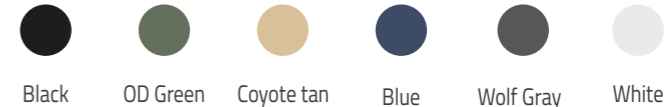

INSTRUCTIONS

LEATHER CARE AND MAINTENANCE

- All Vega Holster leather products will need minimal care and maintenance:
- Clean with a soft cloth and mild soap (don't submerge in water or other liquid)
 - Allow to air dry naturally.
 - You can use a neutral leather cream.
 - Don't use artificial heat to speed up the drying process.
 - Don't use Loctite or others.
 - Don't use solvents or chemical products.

SYNTHETIC CARE AND MAINTENANCE

- All Vega Holster synthetic products will need minimal care and maintenance:
- Clean with a soft cloth and mild soap (don't submerge in water or other liquid).
 - If needed, you can use a soft bristle brush.
 - Allow to air dry naturally.
 - Don't use artificial heat to speed up the drying process.
 - Don't use Loctite or others.
 - Don't use solvents or chemical products.

HOLSTERS CARRY POSITIONS

The most common positions depend on the different needs:

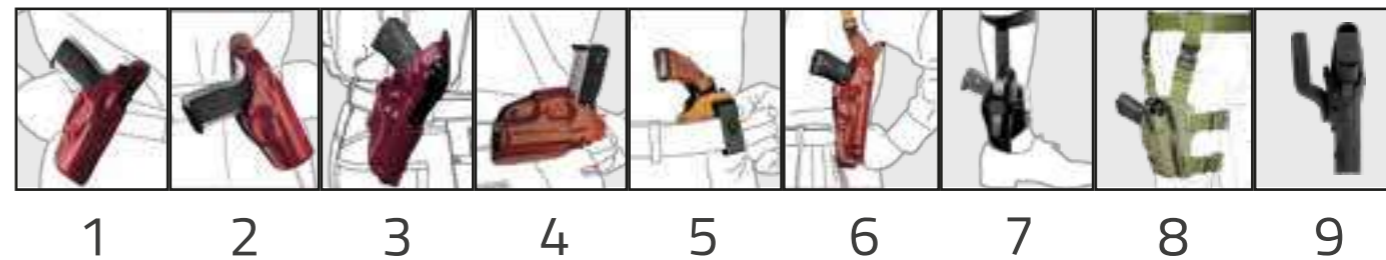

1 ON THE RIGHT SIDE (LEFT FOR LEFT HAND)	CONCEALMENT, DUTY OR MILITARY USES
2 CROSS DRAW ON THE LEFT SIDE (RIGHT FOR LEFT HAND)	CONCEALMENT USE
3 INCLINED ON THE BACK	CONCEALMENT USE
4 HORIZONTAL ON THE BACK	CONCEALMENT USE
5 INSIDE THE PANTS	CONCEALMENT USE
6 HORIZONTAL / VERTICAL / UPSIDE DOWN SHOULDER	CONCEALMENT USE DUTY OR MILITARY
7 ANKLE	CONCEALMENT USE
8 THIGH	DUTY, LAW ENFORCEMENT OR MILITARY USES
9 SIDE WITH A SPECIAL BELT SUPPORT THAT TAKE THE HOLSTER DETACHABLE FROM THE BODY AT THE RIGHT DISTANCE FOR A GOOD EXTRACTION	BODY ARMOUR OR TACTICAL VEST USES. DUTY, LAW ENFORCEMENT OR MILITARY USES.



CARRY SYSTEMS PROGRAM

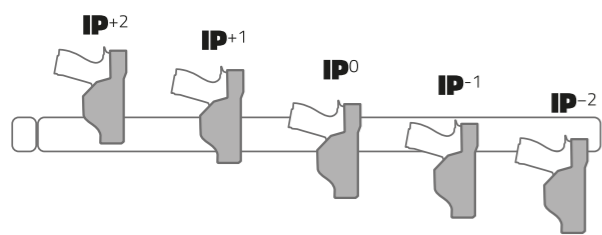

Over the years, security operators have been faced with more demanding and more specific needs, particularly when it comes to how and in what position to carry a short weapon.

Vega has responded to those needs by developing a series of loops and platforms that we call V.C.S.P. "VEGA CARRY SYSTEMS PROGRAM".

The graph below illustrates the relation between the belt line and position of the weapon in the holster.

The IP (Identification of Position) is clearly shown for each loop system that appears in the following pages.

Identification of position is subdivided in 5 values:

IP+2 The weapon grip is very high in respect to the belt. This is especially useful for concealed carrying.

IP+1 The weapon grip is high in respect to the belt. This is useful when use occurs in a vehicle, where the weapon may press on the seat and this create a dangerous situation, or even hinder draw of the weapon.

IP0 The weapon grip is on the belt line. This system is used during normal duty in uniform, allowing a good draw and comfort.

IP-1 The weapon grip is below the belt line. This is ideal for a quick draw.

IP-2 The weapon grip is below the lower belt line. This is ideal for a semi thigh position and a quick and natural draw.

All Vega Holster loops and platforms can be assembled on all Vega holsters with the TRIPLE SCREW fastening system.

Some loop systems permit various holster cants and heights by means of screws, thus, in this case, the above value may differ.

Some loop systems permit varying the cant by means of a lever (without acting on the three fastening screws), this does not change the above value, but the features change (even if a weapon has a rotation angle of 90°, a holster with a value of IP0 or IP-1 will have the possibility of occupying less space when used in a vehicle). Some loop systems are at a certain distance from the body due to the use of tactical and/or bulletproof vests, or to make the draw quicker, or even to avoid accidental snagging while drawing the weapon (This is above all the case of uniformed agents). Other loop systems are closer to the body. These are preferable because of better concealment and an overall feeling of being in control of the weapon against the body.

Naturally, the operator may decide to use different loop systems on his holster (in the event that he does not want to use two different holsters), and choose which to use based on daily operational needs. As an example, the operator may be either on uniformed duty, or plain-clothes duty; in the first case, he will need a holster that can be worn with either a tactical or bulletproof vest while, in the second case, he will need a holster with good concealment.

The choice of a carrying system based on ones operational routine and needs is the first step to having the ideal holster.

WARNINGS

Great Care must be taken when handling, storing or moving firearms or when putting a pistol into or taking it out of the holster. Never put a loaded pistol into the holster without first checking that it fits in properly.

It is the user's responsibility to check personally that the firearm and the holster are compatible.

When placing the pistol into the holster (especially when the holster is new and besides more rigid) support the pistol hammer with your thumb finger and insert it carefully.

When choosing a product, consider first how you dress and how you carry your firearm and then choose the product best suited to your needs, in the appropriate material.

It is of vital importance that the holster and the firearm should be compatible. Before using your new holster, practise drawing the firearm: the holster will adapt better to the firearm and you will get to know the new product.

The firearm and its accessories should be regularly checked to see that they work correctly.

Holsters should never be altered.

Any alteration could cause accidents.

SAFETY GRADES

IT IS THE VEGA HOLSTER SYSTEM OF CLASSIFICATION IN "SAFETY GRADES" OF THE HOLSTERS USED BY POLICE AND IN SPECIAL OPERATIONS, IT IS BASED ON THE SECURITY SYSTEM'S REAL EFFICIENCY USED IN EACH MODEL, CONSIDERING TWO IMPORTANT ELEMENTS:

1) Mental factor: the reaction time in dangerous situation to release the firearm from the holster.

2) Mechanical factor: time necessary to bring the release operation to the end. Both can be improved through practise, good rule to use while handling a firearm, both depend on the quantity and type of the security systems put between the holster and the firearm. Higher is the safety grade, longer is the release time. It is very important to choose a holster with a Safety Grade level suitable with one's real needs.

Example: when an operator is on duty during special operations, it is very important to carry the firearm with the highest safety system, in spite of the release time. On the contrary when an operator faces imminent dangers a medium Safety Grade is recommended, because it is very important to release the firearm in a fast way.

SAFETY GRADE 1 The security system is always a thumb Snap lace. It could be subject to fortuitous release.

SAFETY GRADE 2 The security system doesn't allow fortuitous release and it is unlocked by an only action.

SAFETY GRADE 3 The security system/systems protects the operator from ill-intentioned person, who wants to tear his firearm and gives an excellent protection against fortuitous release. In this case there always are two safety systems acting on two different firearm's part and they can be unhooked and removed by different fingers of the hand (in case the release buttons are separated); or by one only finger, but with two separated and different movements (in case the release buttons are on the same side and near); or by one only finger with one only movement (in case the same lever button acts on both systems).

SAFETY GRADE 4 More security systems. Don't allow fortuitous release, allow a complete protection from ill-intentioned person who wants to tear the operator's firearm. The release is made with different actions in different time. Often a high Safety Grade (3° or 4°) can have more unlocked safety systems, so the same holster can change from Grade 4 to Grade 3 or from Grade 3 to Grade 2.

SAFETY SYSTEMS

VEGA HAS ALWAYS LOOKED FOR THE MARKET PRIORITIES AND SATISFY THE DEMANDS WITH NEW PRODUCTS. THAT'S THE REASON WHY WE CREATE THE BEST SAFETY SYSTEM SUITABLE FOR HOLSTERS.

VEGA CAMA X BACK & GO
The lever has the removable end part to be able to insert different types and dimensions of support. The system can be on Level II, which acts only on the jumper of the weapon, or Level III, which also acts on the upper part of the weapon (in this case both closures can be removed with the same lever).

VEGA THUMB CAMA
Safety system that is activated by a horizontal movement of the thumb, with the movement of the finger on the lever, the upper hood opens frontally and disengages the weapon. For reclosing the hood, manually place it in the upper block position.

VEGA THUMB ALL IN ONE CAMA
Double lock system: one acts on the upper part of the weapon and the second acts on the trigger guard of the weapon. The second one automatically engages when the weapon is replaced in the holster, while the first one is manually engaged. In order to release both systems (either simultaneously or singularly), simply act on one single lever positioned at the rear end of the holster (closer to the body), with a horizontal movement of the thumb.

VEGA INDEX CAMA
Safety system that is activated by a horizontal movement of the index finger. With a movement of the finger on the external lever, the pivot that blocks the trigger guard disengages and the weapon can be drawn. The weapon locks by simply replacing it in the holster.

VEGA THUMB + INDEX CAMA
Double lock system: one acts on the upper part of the weapon and the second acts on the trigger guard of the weapon. The two are independent of each other. The upper one is activated by a horizontal movement of the thumb. With pressure on the lever, the upper hood opens frontally and disengages the weapon. For reclosing the hood, manually place it in the upper block position. The lower one is activated by a horizontal movement of the index finger. With a movement of the finger on the external lever, the pivot that blocks the trigger guard disengages and the weapon can be drawn. The weapon locks by simply replacing it in the holster.

VEGA "AUTOMATIC PUSH AND GO"
Top safety system, push the internal lever and the safety lace go in front, the lace return in safety position manually.

VEGA STOP SNAP
It's a safety blocking of the thumb snap, a safety cap that slide on the plastic lace blocking the snap in the up position and releasing in the down position.

VEGA "PUSH & FRONT"
It's a simple and instinctive semiautomatic safety system that is removable with thumb pressure and insertable with rotation of the plastic lace.

VEGA "PUSH DOWN"
Safety mechanism that work on the trigger guard. The safety lock is automatically activated when the weapon is inserted into the holster and deactivated pushing the inside release lever.

VEGA PULL SIDE
It's a safety system studied to replace the standard security lace, Reinserting the Firearms into the holster the safety catch which acts on the trigger guard is automatically reactivated; to pull out the holster simply pull side the inside lever, it is possible to insert another level of safety with an amovable catch that block the safety lever (it is possible to use the holster with only one safety system for to take out the catch: it is necessary to unscrew the first screw and remove the block cylinder).

"ACE FRONT STOP"
Safety system that automatically enters the insertion of the weapon in the holster and can be unhooked by the thumb of the hand, moving the lever placed between the weapon and the operator's side, in the rear direction (towards the handle). The lever has the removable end part to be able to insert different types and dimensions of support.

ADJUSTABLE SAFETY PUSH & FRONT
Semi-automatic safety system that disengages by placing pressure and pushing forward with the thumb on the surface situated on the external part of the "Rotating lace" and is engaged by manually placing the lace on the weapon hammer. It is possible to block the system by sliding a button which, when moved forward, prevents the lace from sliding downward. The system it can also be adjusted on the front with three slots for to carry the lace near or distant to the weapon hammer.

VEGA PULL FORWARD
It's a manual safety system: the attachment-release is controlled by a lever positioned under the grip. You can block the trigger guard moving the lever back ward; to release it is simply move the lever forward.

GENERAL FEATURES

- Compatible holsters for weapons with Red Dot.
- Retention Screw to adjust the holster retention on the firearm.
- Adjustable Thumb Snap lace to adjust the safety lace according to the firearms.
- Vega Comfort Form is a particular molded system which makes a more comfortable fit.
- Safety Snaps are patented security snaps to release only one side.
- Three way safety buckle. It is released by simultaneous activation of three buttons.

- Anti slip ribbon/lace used particularly in thigh system. The barrel-sight guide allows a free draw and protects the pistol sight.
- The barrel-sight guide allows a free draw and protects the pistol sight.
- Thermo molding directly the firearm to get perfect holster fit.
- All the Vega Holsters are available in left and right hand except few models.
- Adjust angle and removable loop. This Holsters mounts adjust angle and removable belt loops by screws.
- Velcro Modular System: accessories with Velcro back panel, it is possible to mount on compatible bags or induments, it is possible to change the pockets according to the different operative requirements.



Vega Holster is:

▪ **NATO** certified company
Cage Code A7399

▪ **ISO 9001/2015**
certified company

VIA DI MEZZO 31 - 56012 CALCINAIA (PISA) ITALY

Phone ++39 0587 489190 Fax ++39 0587 489901
info@vegaholster.com - www.vegaholster.com



Copyright © Vega Holster srl. All rights reserved.

GRAPHIC DESIGN:  less.g.masoni@less-less.it
CONCEPT: Francesco Toschi



ALWAYS AHEAD



ALWAYS AHEAD